

# Parker

SERVICE MANUAL

No. 6632

15th Edition

*The Parker Pen Company*  
JANESVILLE · WISCONSIN · U. S. A.

**Copyright 1946**

**The Parker Pen Company  
Janesville, Wisconsin**

## Preface

---

Repairing a fountain pen is not as simple as it seems.

No one should attempt to repair or adjust a fountain pen until he is familiar with the mechanical characteristics of that pen. With the help of the directions in this service manual, a dealer can quite easily remedy the ordinary complaints made by a customer.

In a great many of the cases when a customer claims that ink does not flow properly in a fountain pen, it is because the owner of the pen has failed to observe the simplest rule laid down in the instructions concerning fountain pens—namely, to keep the pen point covered and the cap screwed down tightly over it. When the point is left exposed, the molecules of water in the ink are constantly being drawn into the dry air and eventually nothing but dried ink is left around the pen. Naturally, a pen with a dry point cannot write satisfactorily.

If a pen is brought to you in this condition, a simple way to get the pen in working condition is to stand the pen, point downward, in a glass of clear, cold water for an hour or two.

Some people are so thoughtless as to take hold of the nib of the pen with a pair of pliers and attempt to pull it out in this way. Ordinarily this cracks the iridium from the gold and, in any event, it is certain to damage the pen.

A fountain pen is a delicate writing instrument and will obey the laws of natural physics if given the opportunity, but it must have fairly intelligent treatment in order to function as the owner desires and the manufacturer designed it to operate.

This Service Manual is written and prepared for your benefit with the thought in mind that you may be able to give your customers the best kind of service and that extra accommodation which will bring additional business to you in return for the service you give.

# Index

## **The Parker "51" Pen (With Black Band)**

Instructions for Filling.....	6, 7
The Parker "51" Pen.....	8
To Test Ink Capacity.....	9
Sectional View "51" Pen.....	10
Parts of the "51" Pen.....	11
Proper Method of Taking "51" Pen Apart.....	12
To Remove Filler Unit or Shell.....	12
To Remove Point and Feed from Collector.....	13
To Install Filler Unit.....	14
Fitting Point and Feed Into Collector Shell and Barrel.....	15
To Space A Nib.....	16, 17
To Fit Shell On Barrel Over Point.....	18, 19
Final Point Assembly.....	20
To Change Point Without Removing Shell.....	22
To Replace Nib.....	22

## **The Parker Vacumatic Pen**

Sectional View Vacumatic Pen.....	23
Instructions for Filling.....	24, 25
The Vacumatic Filling Action.....	26
Parts of the Vacumatic Pen.....	27
Proper Method of Taking Pen Apart.....	28
To Remove Gold Nib.....	29
To Remove Filler Unit.....	30
To Reassemble Pen.....	30
To Fit Nib and Feed.....	30
To Check Point.....	31
To Increase or Decrease Flow of Ink.....	32
To Refinish or Smooth Up Iridium Point.....	33
To Remove Clip Screw.....	34

## **The Parker Duofold Pen**

Sectional View Duofold Pen.....	35
Instructions for Filling.....	36
Parts of the Duofold Pen.....	37
To Remove Section from Barrel or Sac from Section.....	38
To Fit Point and Feed.....	39
To Insert Pressure Bar.....	40
Pressure Bars.....	41

Leaking .....	42
Proper Care of Fountain Pen.....	43
Reference Fitting Chart for Repair Assembly.....	44, 45
To Keep Pens Clean.....	46
To Remove Stains from Barrel.....	46
Parker Repair Tool Assortment No. 320.....	47, 48
Engraving Crayon and Liquid Polish.....	49
Parker Gold Pen Points.....	50
Pencil Point Drill, Screw Driver and Lead Cartridge.....	51
Parker Writefine Pencil.....	52
Parts for the Parker Writefine Pencil.....	53

Important  
Interesting and Helpful  
**Service Instructions**  
For Parker "51"  
with Black Band



*Like a Pen*  
*from another* **PLANET**

**THE**  
**Parker "51"**

## INSTRUCTIONS FOR FILLING THE "51" PEN

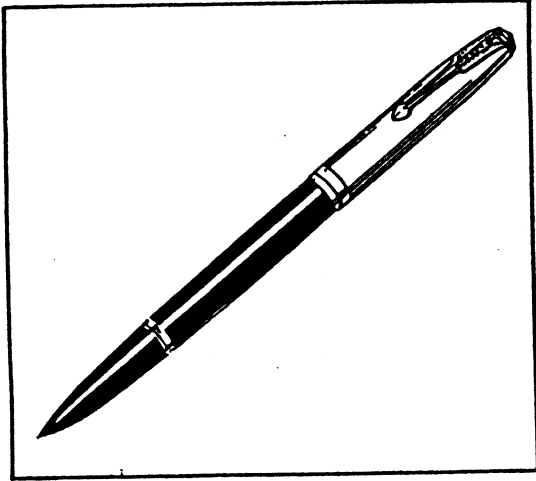

The Parker "51" is a totally new departure in writing instruments. You should thoroughly familiarize yourself with its handling in order to obtain the distinctive performance it is built to render.

Frankly the "51" is not designed for anybody and everybody any more than a \$300 candid camera is built for promiscuous ownership. Used understandingly, the Parker "51" is without any question the most highly refined and perfected writing instrument yet developed.

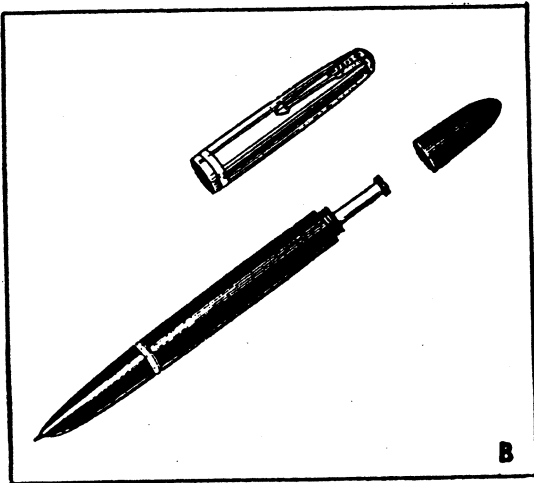

1st. Unscrew small cap at rear end of the barrel exposing filling plunger as shown in Fig. B.

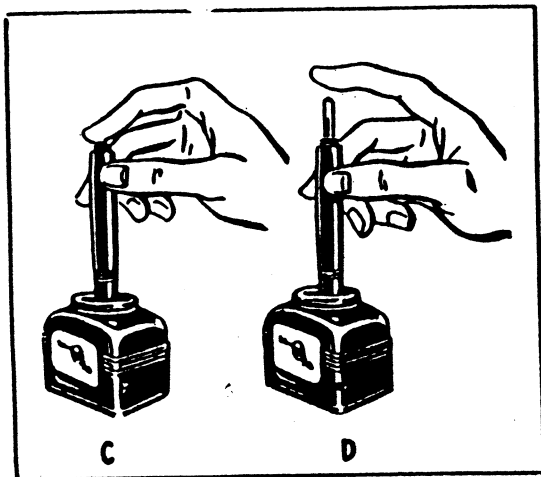

2nd. Hold pen as shown in Fig. C. Immerse pen point in ink.

Then press and release the plunger briskly about 10 times, pausing at top of each stroke. See Fig. D.

PARKER "51" PEN WITH BLACK BAND

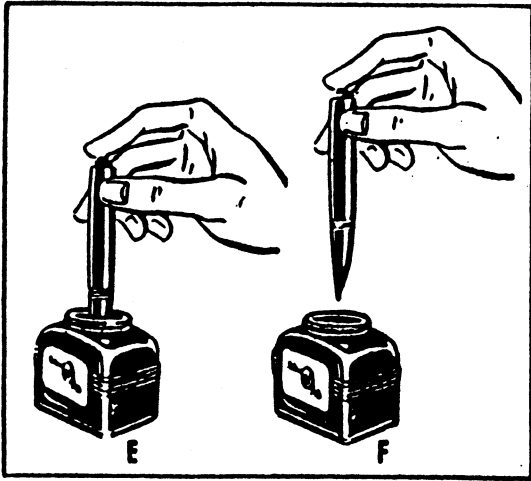

3rd. On the last or final stroke hold the plunger down, lift the pen from the ink.

See Fig. E.

When pen is removed from bottle of ink let the plunger rise.

See Fig. F.

This one hand filling operation is very simple, yet easy to do wrong. Just remember to make the last upward stroke of the plunger after the pen is out of the ink as this clears surplus ink from the ink trap chamber. Otherwise the pen will flow too heavily when you first start to write and may leak.

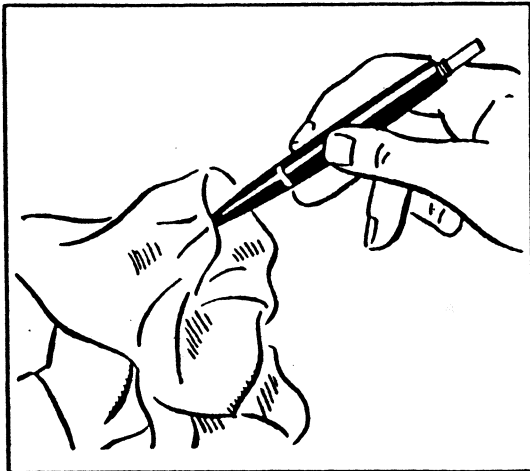

AFTER FILLING

After the Parker "51" pen is filled, wipe the point carefully with a cloth. This serves a double purpose of wiping off the excess ink and starting the flow of ink down the ink channel.

Carry the pen vertically, with the cap upright, even when in a handbag.

Always keep cap securely on pen when not in use.

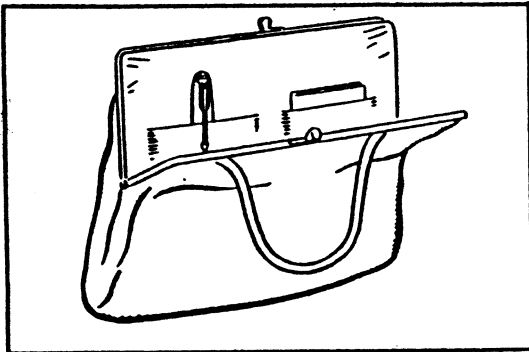

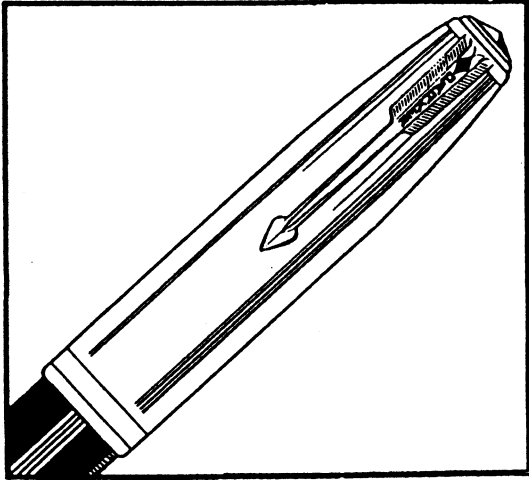

### THE NAME "51"

The Parker "51" is so called because its development was completed in 1939, the Company's 51st year in business.

Eleven years of chemical, physical and engineering research were spent to evolve this matchless writing instrument.

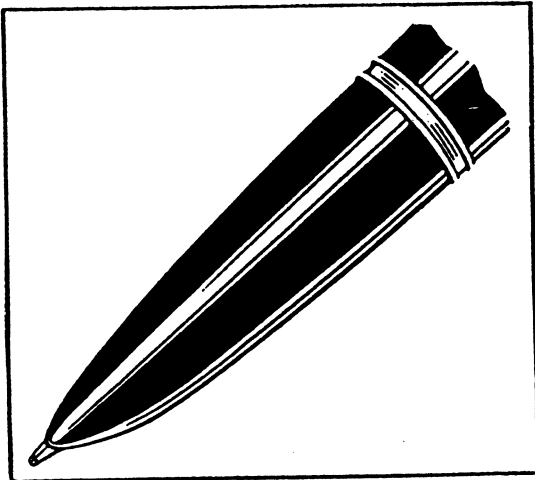

### ENCLOSED 14K GOLD TUBULAR POINT

Here is a history-making innovation in Pen Points — the first point ever to be enclosed within the barrel, keeping it always moist and guarding both point and feed as the case of your watch protects its works. A long tubular point whose size, shape and weight require more 14K Gold than most standard shaped points.

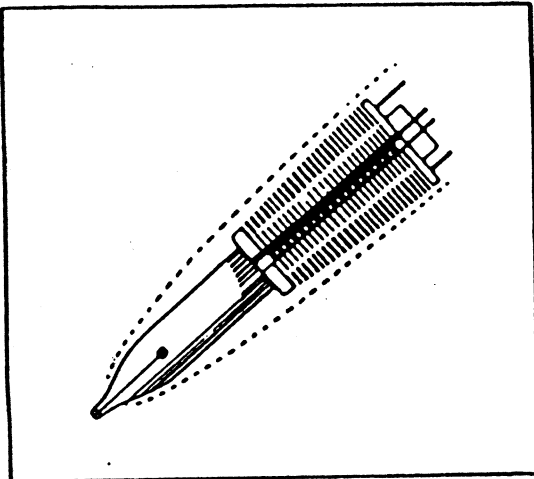

### THE PATENTED INK TRAP

Another epochal achievement, the ink trap, a cylindrical comb, traps any overflow —traps it inside, so it cannot get on hands or clothes—makes the Parker "51" a pen that won't sweat, flood or leak.

Instruct the customer they should never attempt to remove front end or tamper with the parts in any way.

The ink trap is shown in the phantom illustration. In the filling operation, surplus ink should be cleared from the ink trap, as explained on page 7.



---

PARKER "51" PEN WITH BLACK BAND

---

**TO TEST INK CAPACITY OF "51" PENS**

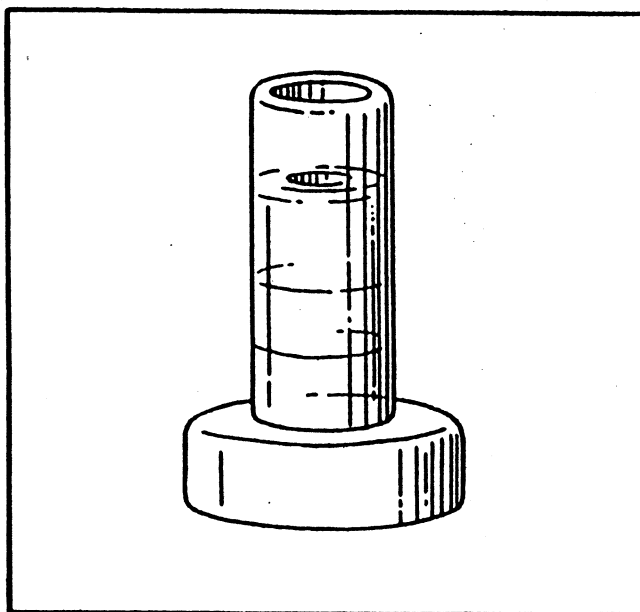

**"51" Capacity Tube Gauge**

Fill tube to top line with "51" Ink. Then place pen in tube. Push plunger down ten times keeping plunger down on tenth stroke, then take pen out of tube and release plunger.

If ink level is down to lower line, pen fills properly.

This filling gauge can be used to demonstrate the proper method of filling and at the same time demonstrate that the pen actually holds a generous ink supply.

---

## GENEROUS "51" INK CAPACITY

The "51" pen will take in the full ink capacity only if the filling instructions are properly followed.

### IMPORTANT

The "51" pen, due to the cell-like structure in the front end, is difficult to empty by manual operation of the plunger. This, of course, also keeps the pen from leaking. It requires from 20 to 30 very slow strokes of the plunger to empty the pen. This is something that people almost never want to do, and we mention it only because it has led some owners to believe that there was not much ink in the barrel.

### SECTIONAL VIEW "51" PEN

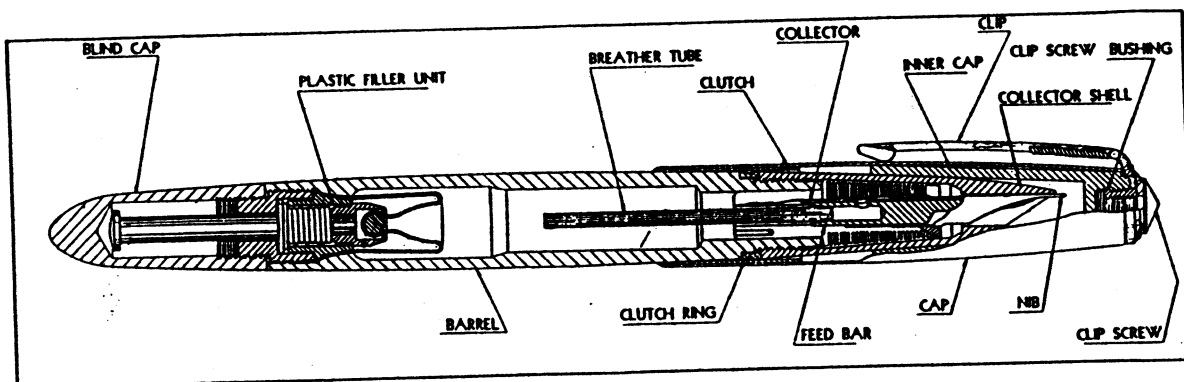

---

PARKER "51" PEN WITH BLACK BAND

---

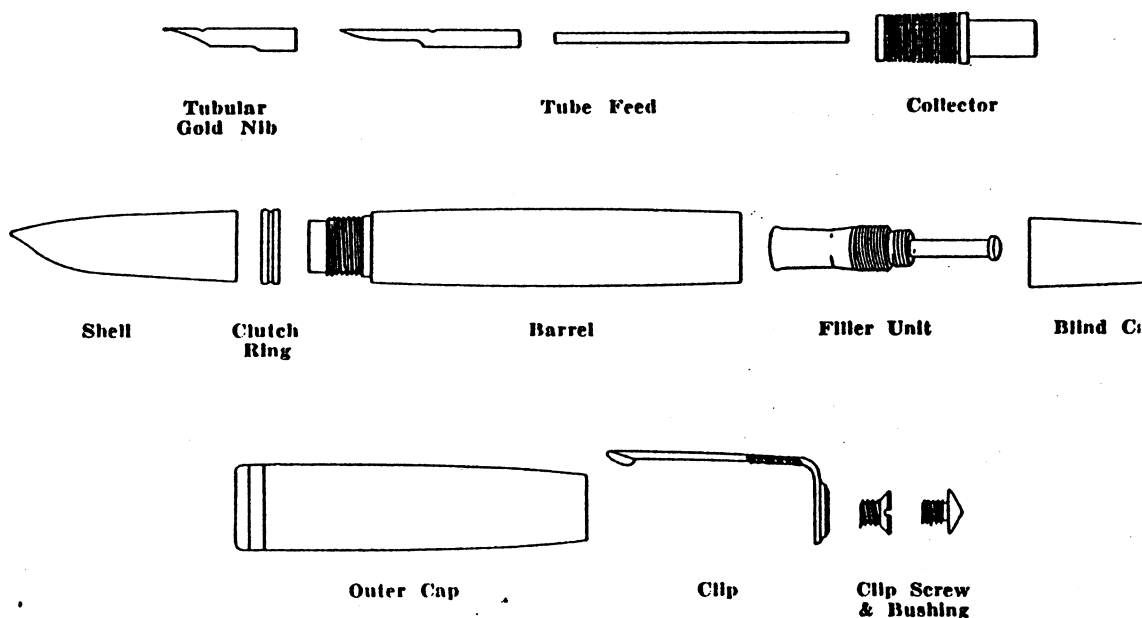

**PARTS OF THE "51" PEN**

**Tubular Gold Nib.** Made of 14K Gold, tipped with highest quality Ruthenium.  
List Price - \$3.50

**Feed and Breather Tube Assembly.** Hard rubber feed and saran breather tube.  
List Price - .30

**Collector.** Made of DuPont Lucite Methyl Methacrylate Plastic.  
List Price - .70

**Collector Shell.** Made of DuPont Lucite Methyl Methacrylate Plastic.  
List Price - .90

**Clutch Ring.** Made of stainless steel.  
List Price - .15

**Filler Unit.** Made of aluminum coupling, aluminum connection, stainless steel spring, plastic plunger and carrier and rubber diaphragm.  
List Price - .60

**Barrel.** Made of Lucite Methyl Methacrylate Plastic.  
List Price - \$1.80

**Blind Cap.** Made of Lucite Methyl Methacrylate Plastic.  
List Price - .50 — Signet model .75 — Heritage and Heirloom \$1.50

**Cap.** Made of Metal, stainless Lustraloy steel, silver or gold filled. Inside is fitted with plastic inner cap and stainless steel clutch.  
List Price - Gold filled \$6.50 — Silver and Lustraloy \$4.00 — Heirloom \$29.00

**Clip.** Blue Diamond. Gold filled on silver or bronze metal base.  
List Price - .60 — Heritage and Heirloom \$12.60

**Clip Screw and Bushing.** Clip screw is pyralin and bushing is brass.  
List Price - .10

---

## PROPER METHOD TO TAKE "51" PEN APART

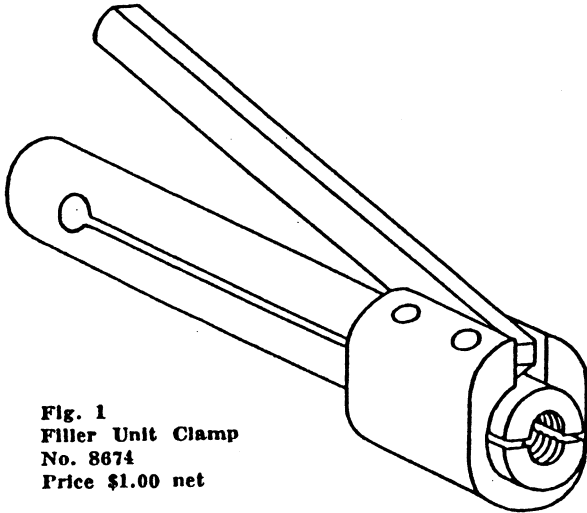

Fig. 1  
 Filler Unit Clamp  
 No. 8674  
 Price \$1.00 net

### TO REMOVE FILLER UNIT

Place filler unit clamp Fig. 1 in right hand. Hold pen in left hand. Then screw butt end of barrel into clamp snugly. See Fig. 2. Then squeeze lever of clamp onto filler unit threads and turn clamp counter-clockwise using flat piece of rubber in palm of left hand and pen holder. Remove filler unit.

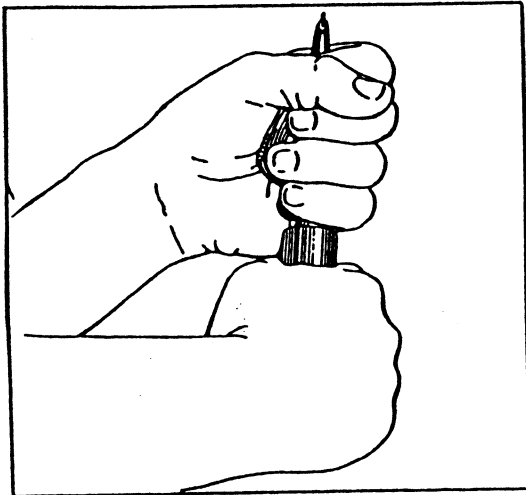

Fig. 2

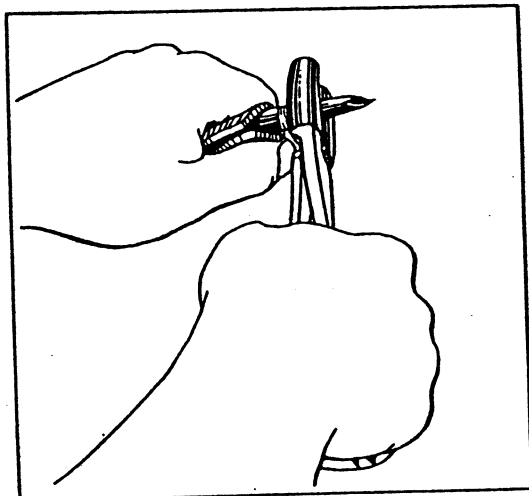
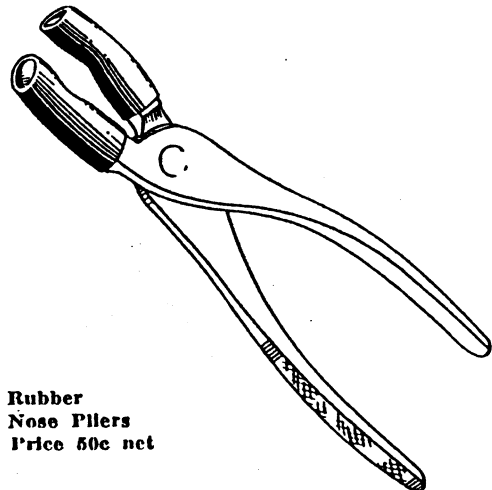

Fig. 3

### TO REMOVE SHELL

Hold pen in left hand firmly with flat rubber in palm of left hand with point up. Put rubber nosed pliers over shell near clutch ring and squeeze snugly, not too tightly, and turn counter-clockwise. See Fig. 3 to remove shell.

If rubber becomes worn, turn to fresh surface to avoid marring parts.



Rubber  
 Nose Pliers  
 Price 50c net

---

PARKER "51" PEN WITH BLACK BAND

---

**TO REMOVE POINT AND FEED FROM COLLECTOR**

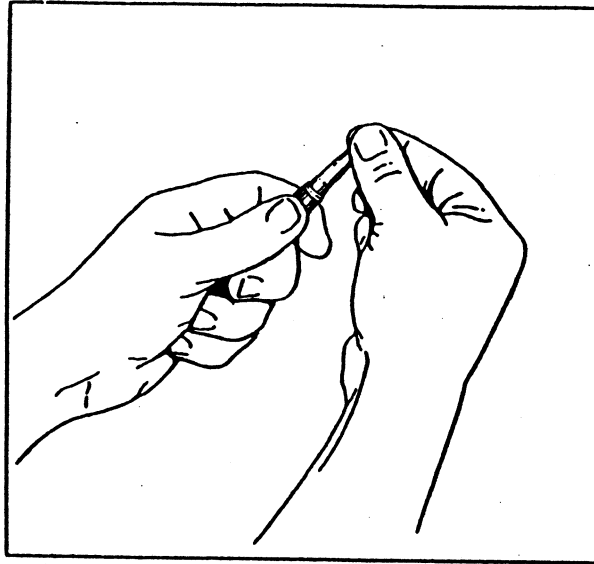

Fig. 1

1st. Hold pen in left hand, point up.

Remove point with forefinger and thumb of right hand by gripping holder with left hand and pulling point out with right hand. See Fig. 1.

2nd. Then remove feed from collector using same method as per above.

3rd. Pull out collector by hand using forefinger and thumb of right hand turning right and left and pulling barrel toward you at same time.

Remove clutch ring. See Fig. 2.

After completely dismantled, all parts are to be thoroughly cleaned before reassembling.

Be sure that collector fins are free from any dirt or sediment and that no fins are broken.

Rinse all parts with cold water, or vinegar and water, or ammonia and water.

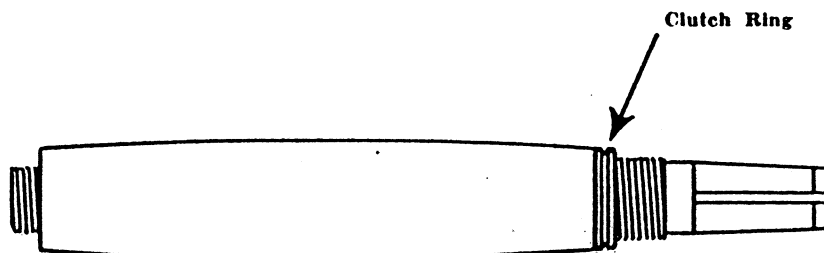
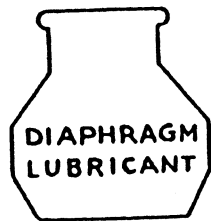

FIG. 2

---

## TO INSTALL THE FILLER UNIT



Diaphragm Lubricant  
10c net

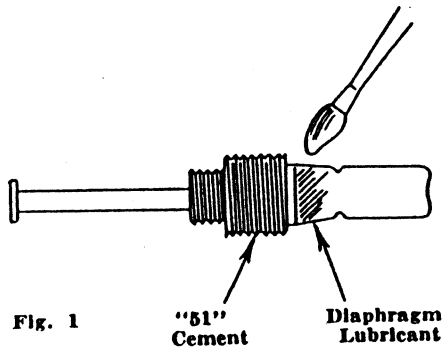

Fig. 1

Be sure that all old rubber parts are removed from barrel and barrel is dry on inside. Place diaphragm lubricant on end of diaphragm, see Fig. 1, with small camel hair brush. Then place small quantity of "51" cement on top of threads. See Fig. 1.

Push plunger down before inserting into barrel.

Then screw filler unit in butt end of barrel about two or three turns with forefinger and thumb. See Fig. 2.

Next screw filler unit clamp half way on filler unit threads.

Then hold barrel in left hand using flat rubber in palm. Hold tightly and squeeze lever on clamp firmly with right hand and turn both barrel and clamp with both hands in opposite directions until filler unit fits snugly. See Fig. 3.

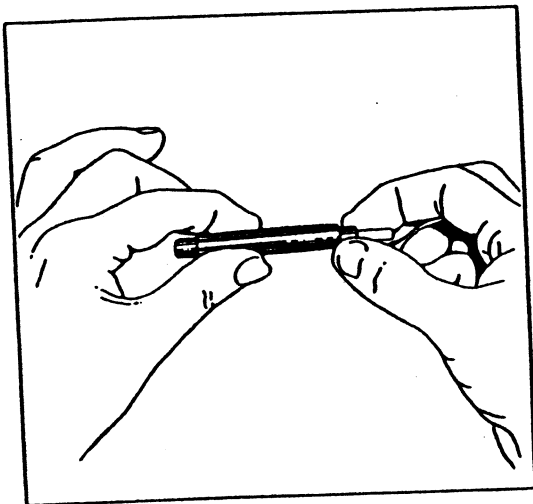

Fig. 2

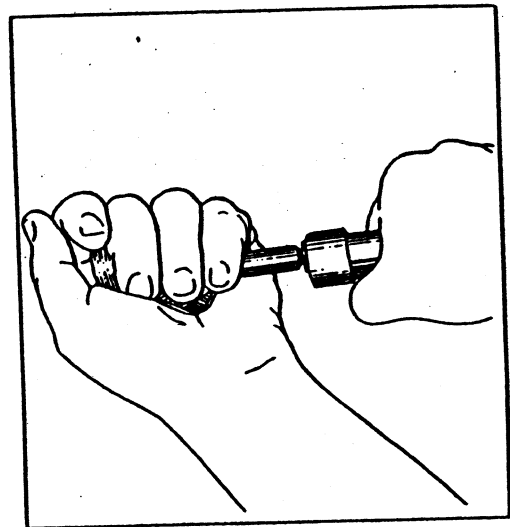
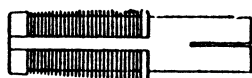
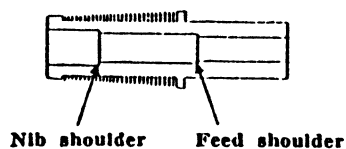
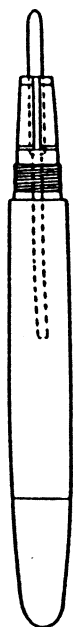

Fig. 3

## FITTING POINT AND FEED INTO COLLECTOR SHELL AND BARREL



Wide channel  
on top



Hold barrel in left hand, push collector into barrel with wide channel of collector facing you. Be sure collector is snug but not too tight to turn and yet not too loose.

Then insert feed tube first into the front end of the collector in such a way that the rounded top of the feed is lined up with the wide channel on top of the collector and the air hole in the feed is directly in line with the wide channel in the top of the collector.

Push the feed all the way into the collector until it stops against the feed shoulder inside of the collector.

To fit point hold barrel in left hand. Hold point in thumb and forefinger of right hand pushing over the feed into collector so that the pierced hole in the nib lines up with the wide channel of the collector.

After point is set properly in collector and feed, there must be a slight space between the points. To space the prongs use the thumb-nail and pry the prongs apart just a little.

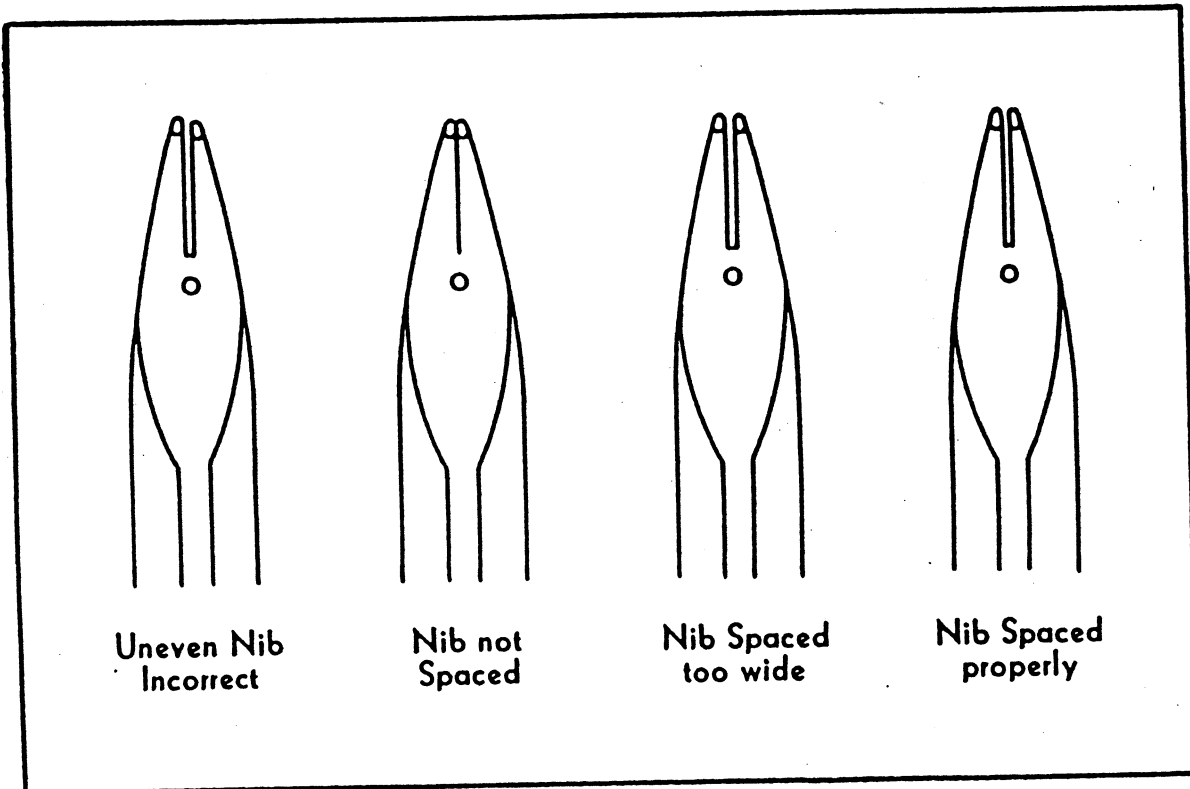
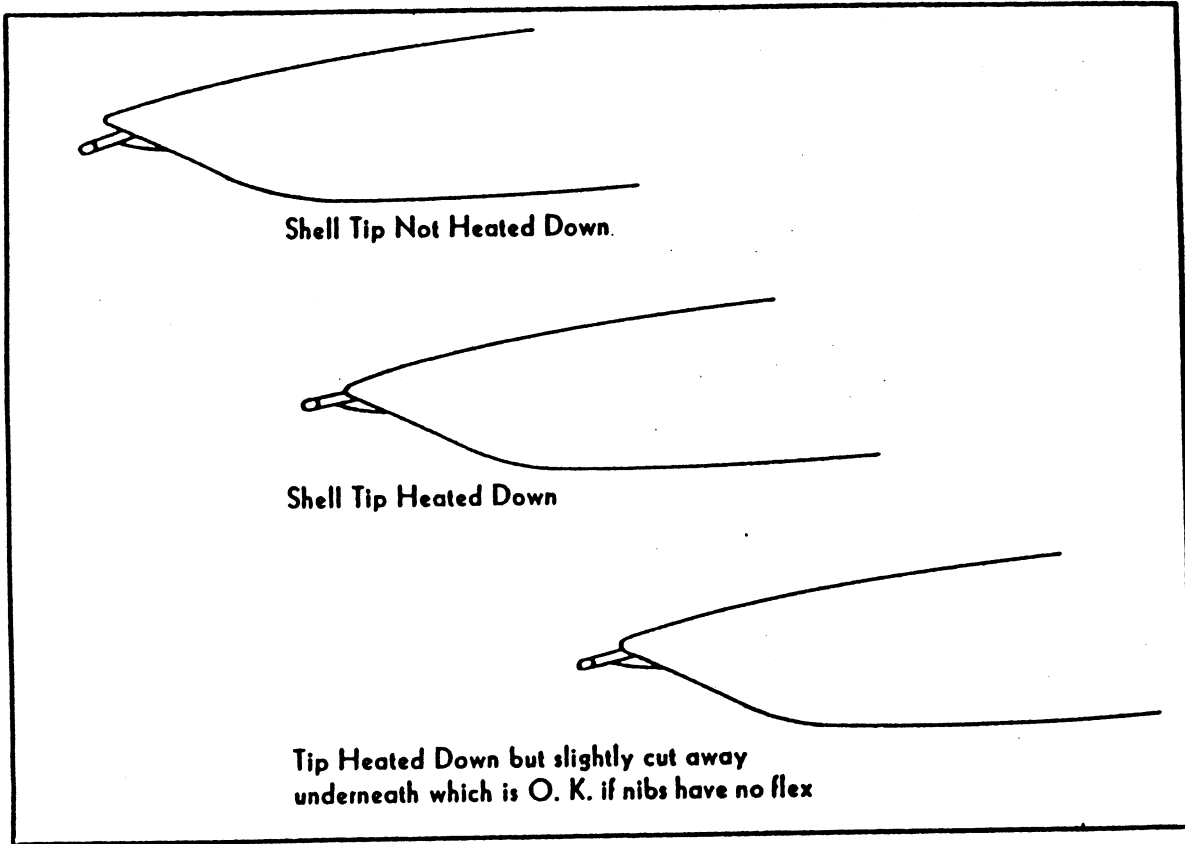



PARKER "51" PEN WITH BLACK BAND

---

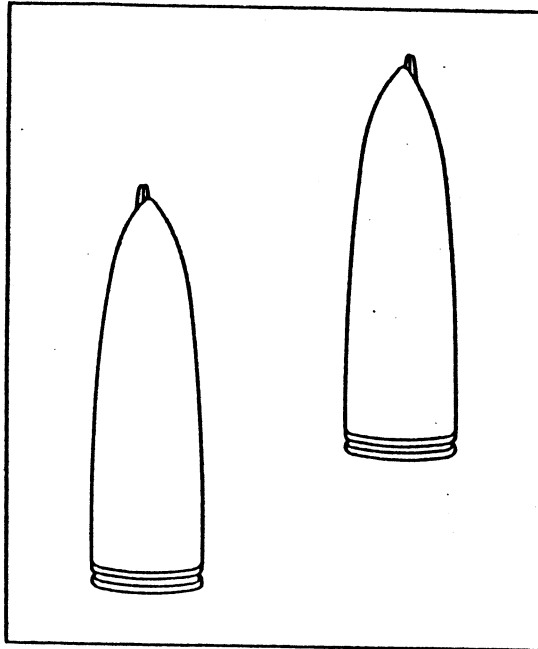

Fig. 1

If after cementing shell tightly on barrel, the point is still off center to the left or right, see Fig. 1, remove shell and repeat procedure as shown on page 18.

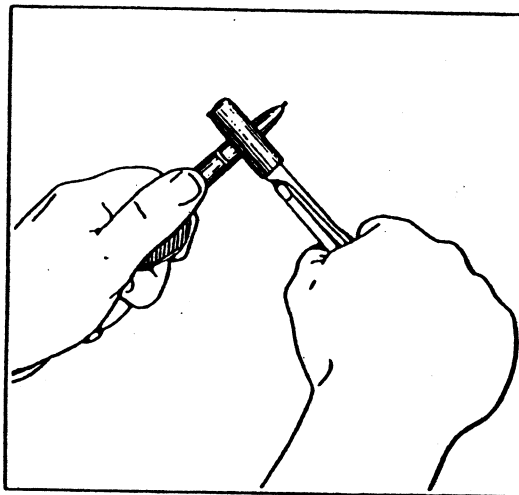
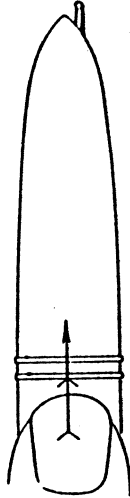

Fig. 2

Then hold shell tightly with rubber nosed plier just above clutch ring with right hand and turn barrel with flat rubber in palm of left hand toward you until barrel is tight. See Fig. 2: If this does not line up, repeat operation as shown on page 18. Do not exert undue pressure on shell.

---

## TO FIT THE SHELL ON BARREL OVER POINT



Gold Nib off center

When the shell is screwed in the barrel over the point, it is not possible to know in advance the position in which the shell will stop. Frequently the gold nib will not line up with the shell front.

After screwing the shell on snugly, hold the thumb of your left hand on the barrel in line with the shell tip.

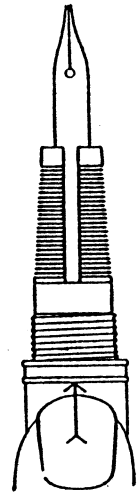

Turn Collector

Then remove the shell with the right hand and turn the collector around until the gold nib lines up with your thumb.

Again screw the shell on snugly by hand to make sure that the shell tip lines up correctly with the gold nib. If it does, remove shell and apply a little "51" cement all around the threads of barrel. The cement will make a leak proof joint. Screw shell tightly on the barrel with rubber nosed pliers.

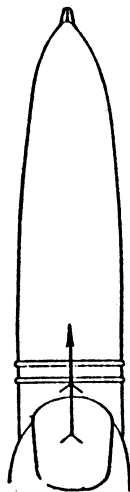

Gold Nib centered

Caution: Keep open bottle of "51" cement away from any exposed flame.

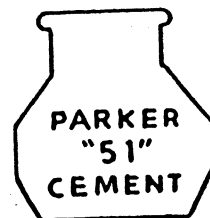

Parker "51" Cement  
10c net

---

PARKER "51" PEN WITH BLACK BAND

---

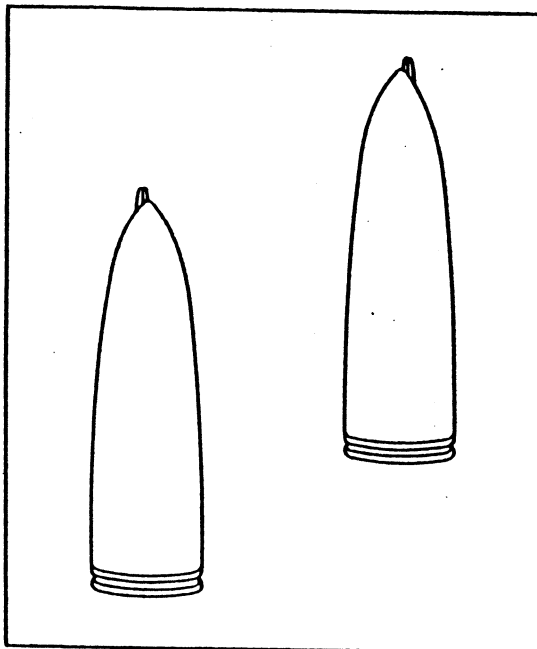

Fig. 1

If after cementing shell tightly on barrel, the point is still off center to the left or right, see Fig. 1, remove shell and repeat procedure as shown on page 18.

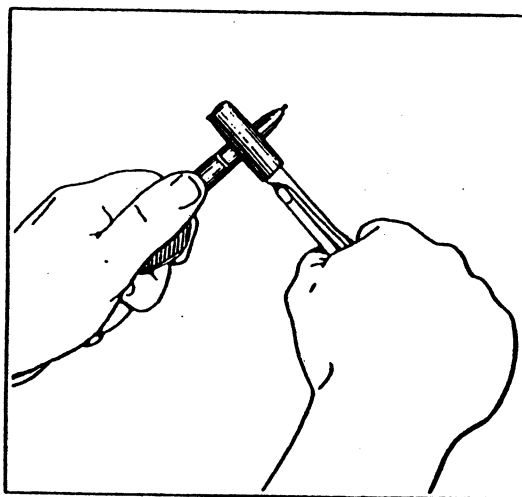

Fig. 2

Then hold shell tightly with rubber nosed plier just above clutch ring with right hand and turn barrel with flat rubber in palm of left hand toward you until barrel is tight. See Fig. 2. If this does not line up, repeat operation as shown on page 1. Do not exert undue pressure on shell.

---

## AFTER FINAL POINT ASSEMBLY

The tip of the shell must lie tightly against the gold nib.

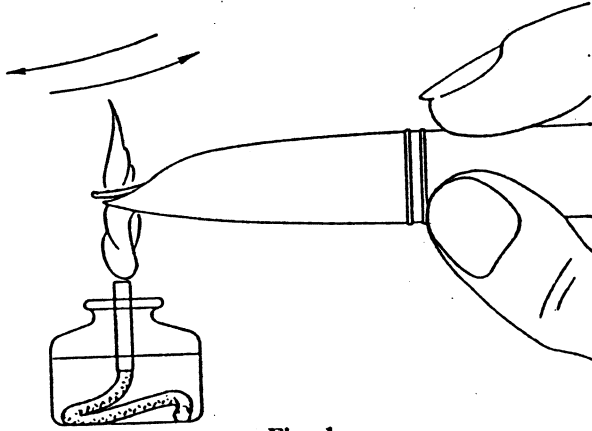

Fig. 1

To accomplish this, heat the tip of the shell by passing it through an alcohol flame several times.

Move it from side to side or it will burn. A little heat will suffice to soften the tip of the shell. See Fig. 1.

Now rub it against the palm of your left hand so that the shell tip will fit tightly against the gold point See Fig. 2.

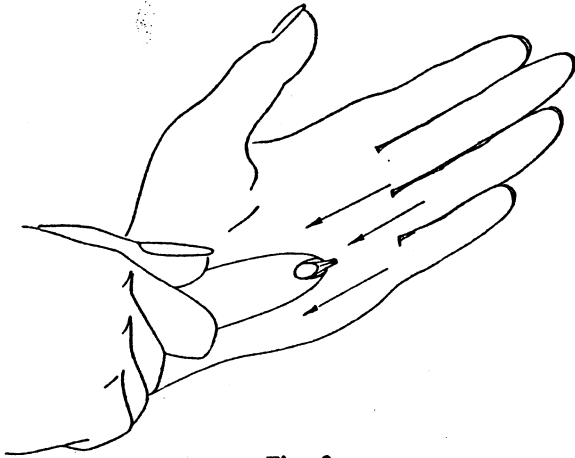
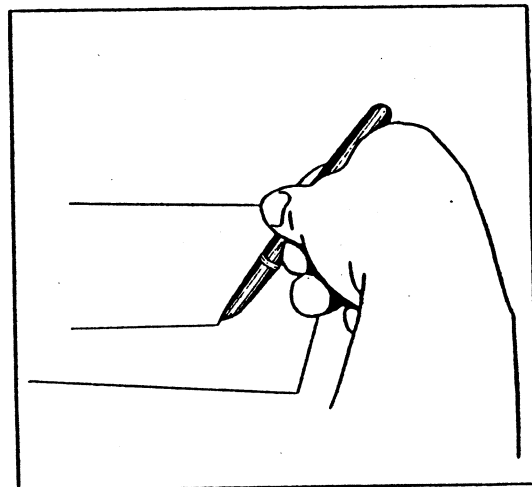
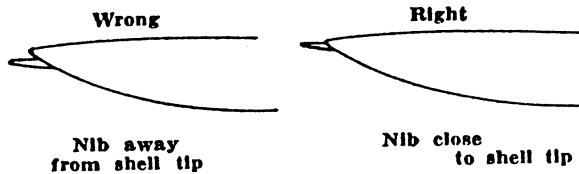

Fig. 2

Allow a few seconds to cool in air. Then fill or dip to test flow.

Sometimes this procedure of heating down causes the shell tip to press too tightly against the nib thus closing the prongs and preventing the ink from flowing. In that case reheat the shell tip just a little, same as in Fig. 1.

Then while tip is still warm draw some lines using downward strokes with slight pressure. This will open prongs slightly.



---

PARKER "51" PEN WITH BLACK BAND

---

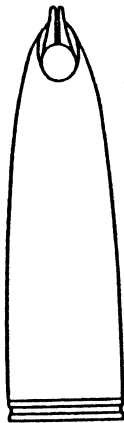
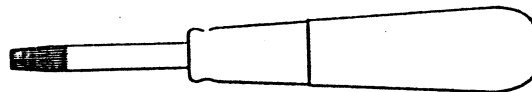

Fig. 1

Nib properly spaced. See Fig. 1.  
Test for proper degrees of spacing  
with nib gauge as shown on page 17.



Inner Cap Arbor  
No. 8057  
Price \$1.00 net

Insert arbor tightly in cap to give a solid  
grip while tightening clip bushing and clip  
screw.

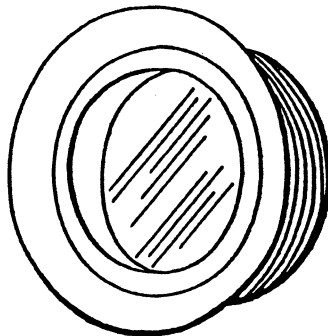

Magnifying Glass  
Bausch & Lomb Lens  
Power No. 7  
Price \$1.00 net

---

### TO CHANGE POINT WITHOUT REMOVING SHELL

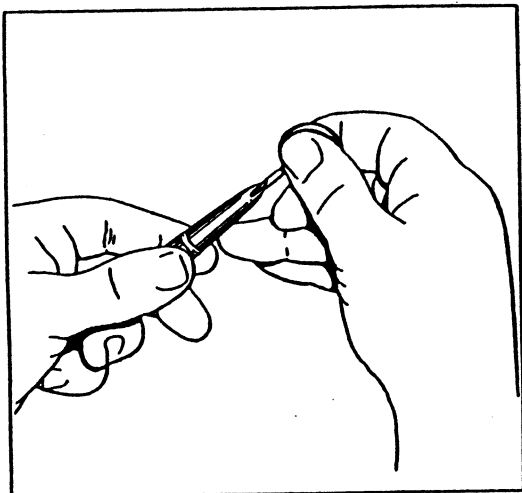

Hold pen in left hand with feed facing up. Place nib puller at top of feed, pressing downward and slipping nib puller under feed until knob on puller engages hole in nib, then pull both left and right hand in opposite directions to pull out nib.

### TO REPLACE NIB

First space nib with thumb pressure and see that both prongs are even. Then push nib into shell over feed with forefinger and thumb of right hand lining tip of shell with slit in nib with enough pressure to hold in position. Then press end of nib on hard surface until nib hits shoulder of collector. Heat shell if necessary.

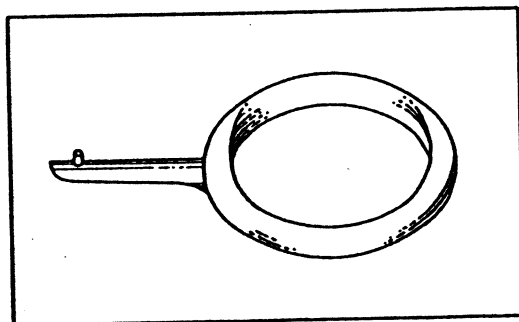
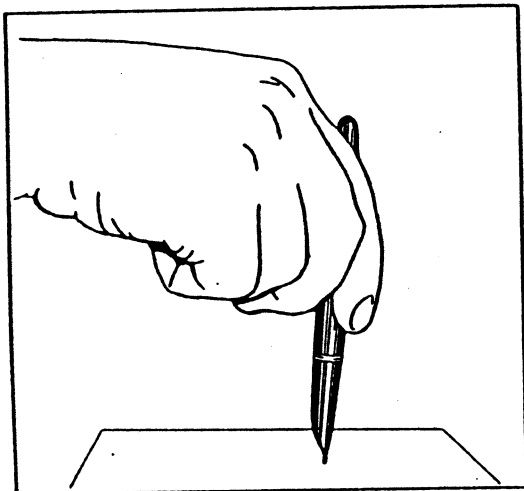
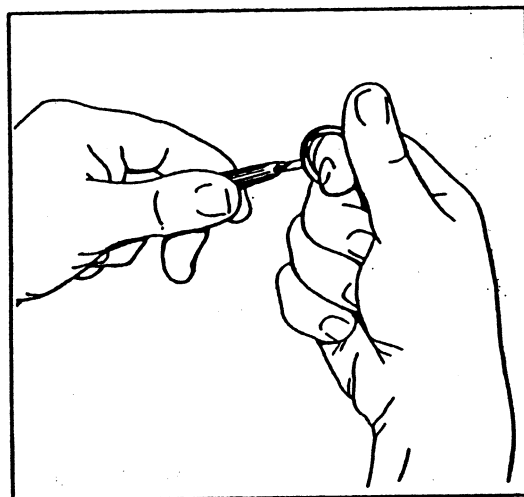

"51" Point Remover. No. 8573RI  
Price \$1.00 net

---

THE PARKER VACUMATIC PEN

---

# The Parker Vacumatic Pen

## SECTIONAL VIEW VACUMATIC PEN

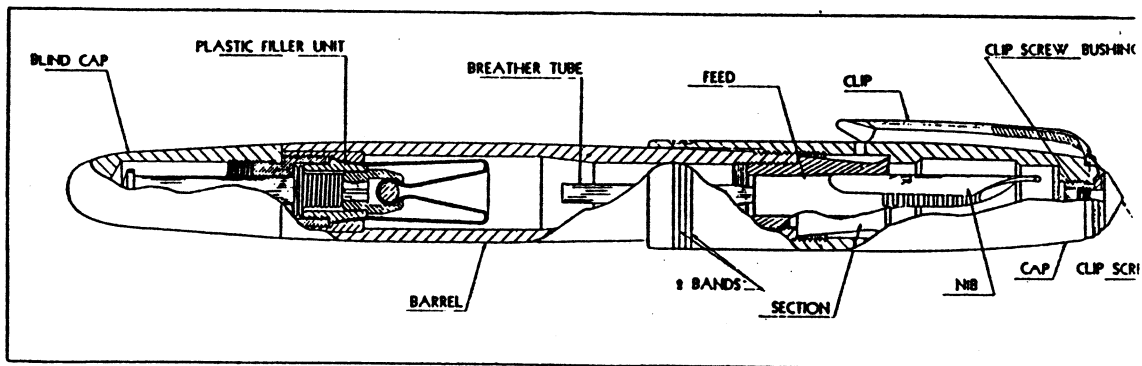

## INSTRUCTIONS FOR FILLING THE PARKER VACUMATIC PEN EXTENDED FILLER MODELS

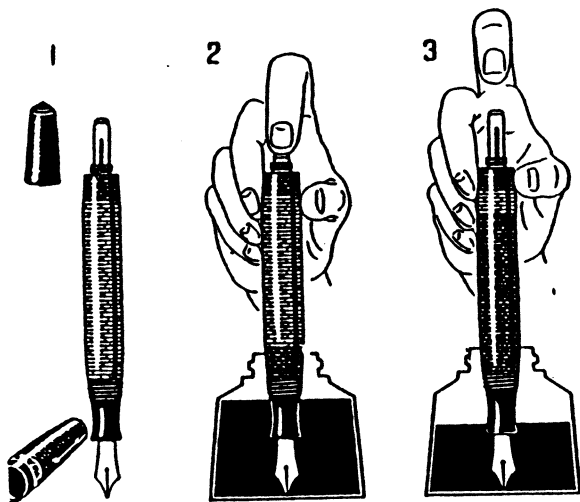

Unscrew and remove the small cap on the end of the barrel as in Fig. 1. Immerse the gold pen point completely in ink. Depress the filling plunger ten times as shown by Fig. 2. Pause a second at the top of each stroke, as shown in Fig. 3. By holding the ink bottle with the pen in it against the light, you may watch the transparent laminations and see how the barrel fills completely with ink.

After the pen is filled replace the small cap.

## LOCK FILLER MODELS (Manufacture Discontinued)

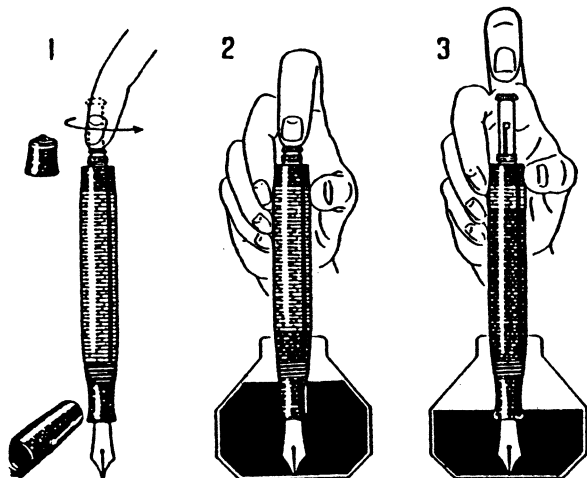

After unscrewing and removing the small cap on end of barrel, release the filler plunger by pressing and turning slightly to left. Plunger will then extend. See Fig. 1.

Immerse the gold pen point completely in ink. Depress the filler plunger ten times, making the down and up strokes quickly, but pause a second at the top of each stroke. Pausing between strokes gives the ink time to flow in. See Figs. 2 and 3.

Sometimes more than ten strokes are required, depending upon the size of the pen. When pen is full, depress the filler plunger and re-engage it by turning it to the right before removing the pen from the ink bottle.



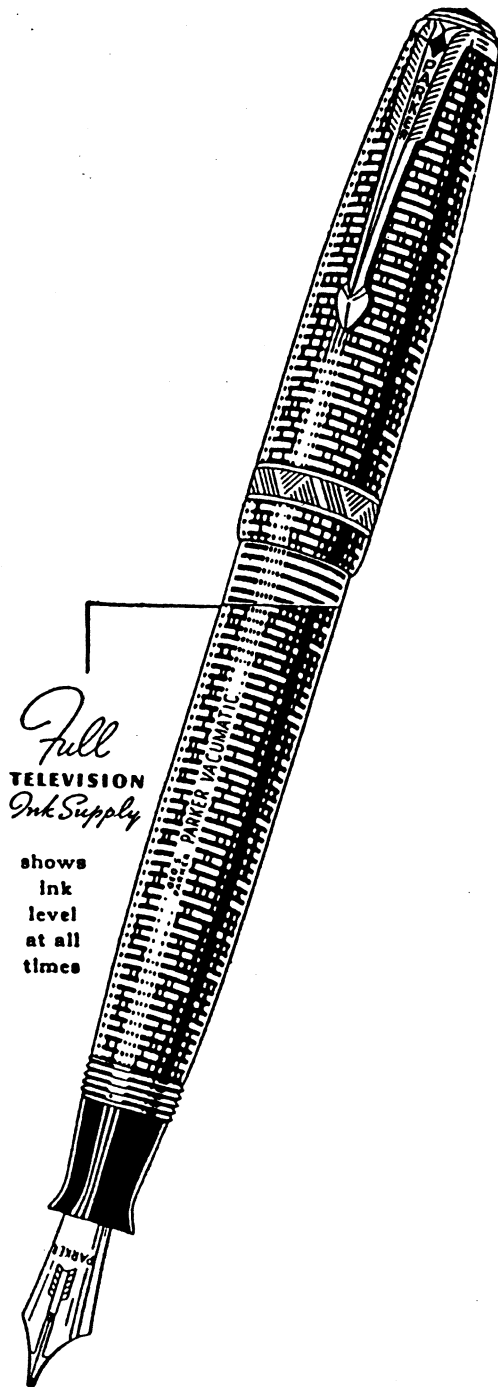

The Parker Vacumatic pen when held to the light, shows the quantity of ink indicating to the user when to refill and thus ending the inconvenience caused by a pen running dry in the midst of writing.

Keep the outer cap screwed tightly on the pen when not in use. This will keep the pen point always moist and ready for immediate use.

Never flush the pen with hot water, alcohol, acids or anything except cold water. Anything but cold water is almost certain to damage the pen.

### TO EMPTY THE PEN

To empty the Parker Vacumatic pen, push down filler plunger very slowly. The slow pressure allows the ink to be expelled in drops. Release the plunger and repeat until the pen is empty.

It is necessary to clean the fountain pen from time to time in order to keep it in good condition. Fill the pen with water and let it stand point down in a glass of water. This dissolves and removes all ink crusts.

THE VACUMATIC FILLING ACTION

In the cut below you will see that there is a breather tube running from the feed up through the center of the barrel. When the diaphragm is distended as the plunger is pushed down, air in the barrel is forced out through the breather tube. When plunger is released, contracting the diaphragm, a vacuum is created in the barrel into which the ink rushes, passing through channel in feed.

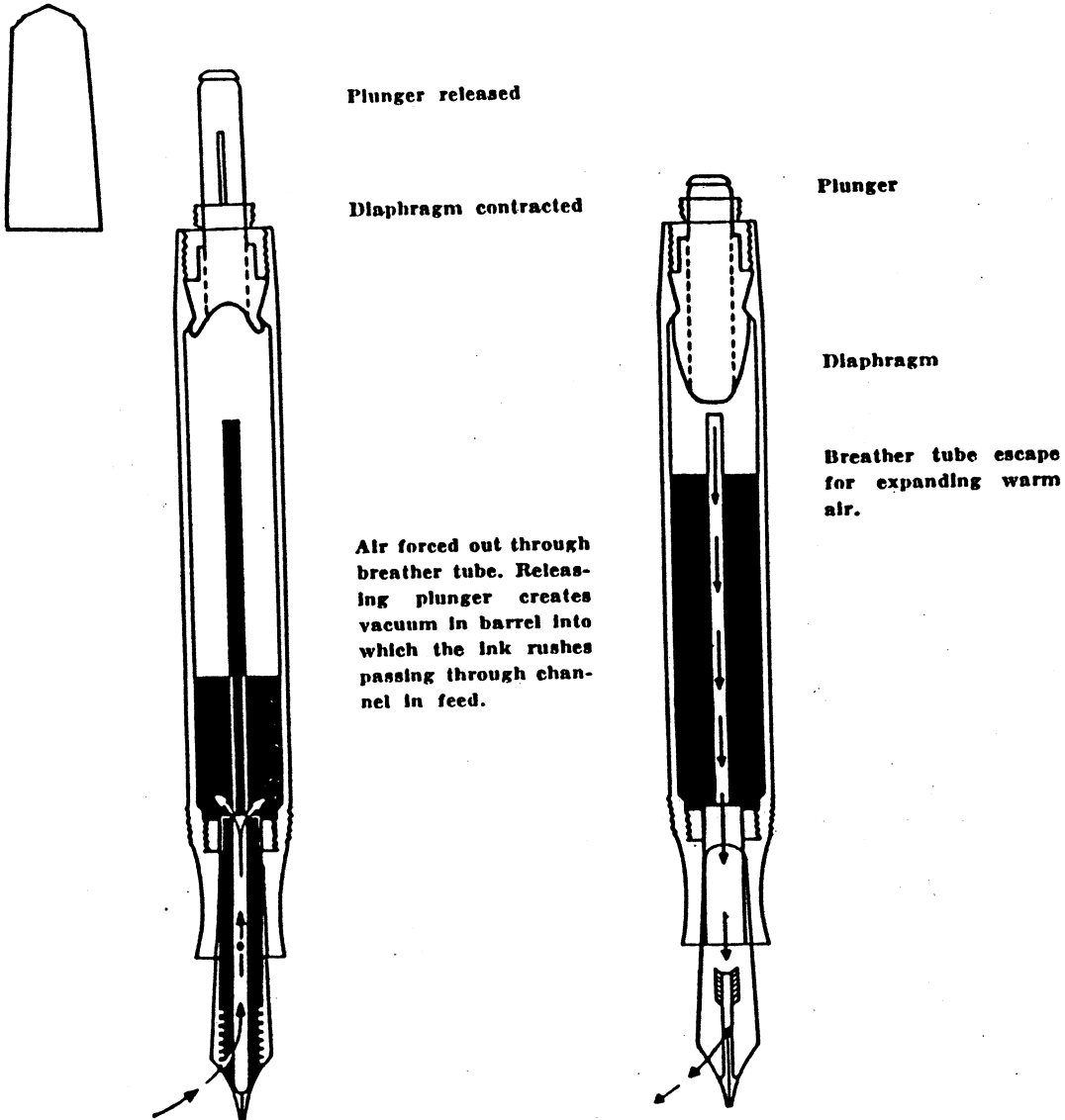

## PARTS OF THE PARKER VACUMATIC PEN



Gold nib



Tube feed



Section

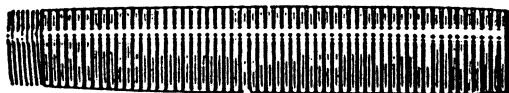

Barrel



Filler Unit



Diaphragm



Filling Mechanism

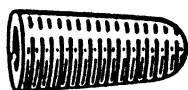

Blind Cap



Outer Cap

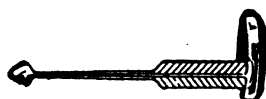

Clip



Clip Screw

**Gold Nib.** Made of 14K gold, tipped with highest quality Ruthenium. List Price: Junior, Sub-Deb, Standard and Slender \$2.00; Major, Debutante, Imperial Debutante and Imperial Major \$3.50; Maxima \$4.00.

**Tube Feed Assembly.** Hard rubber feed and saran breather tube.

**Section.** Made of DuPont Pyralin. List Price: Junior and Sub-Deb \$ .20; all others \$ .30.

**Barrel.** Made of laminated unbreakable DuPont Pyralin. Patented by and exclusive with Parker. List Price: Junior and Sub-Deb \$ .80; Standard, Slender, Major, Debutante and Imperial Debutante \$1.20; Maxima and Imperial Major \$1.80

**Filler Unit.** Consists of filler mechanism and diaphragm. Extended type plastic plunger. List Price: \$ .60.

**Diaphragm.** Made of rubber.

**Filler Unit.** Made of aluminum coupling, aluminum connection, stainless steel spring, lock type metal plunger and carrier.

**Blind Cap.** Made of Pyralin. Unit consists of blind cap, band and clip screw. List Price: Junior and Sub-Deb \$ .20; Standard and Slender \$ .40; Major, Debutante, Maxima, Imperial Debutante and Imperial Major \$ .50.

**Outer Cap.** Made of Pyralin, mounted with gold plated bands. Inside is fitted with inner cap which provides an airtight chamber for the nib when the pen is closed. List Price: Junior and Sub-Deb \$ .70; Standard and Slender \$1.10; Major and Debutante \$1.70; Maxima \$2.00; Imperial Debutante \$5.75; Imperial Major \$6.00.

**Clip.** Silver or bronze spring metal covered with rolled gold. White gold clips are covered with rolled gold and plated with chromium. List Price: \$ .60.

**Clip Screw and Bushing.** Clip Screw is Pyralin. Bushing is brass. List Price: \$ .10

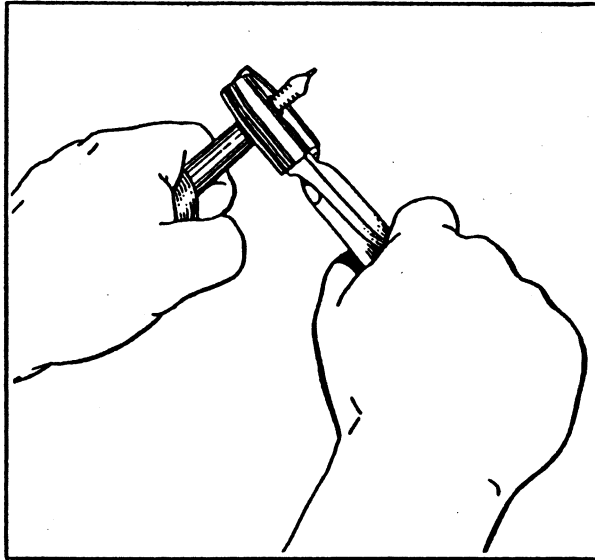
**PROPER METHOD TO TAKE VACUMATIC PEN APART****TO REMOVE SECTION POINT AND FEED**

Place flat piece of rubber in palm of left hand, grip pen barrel firmly. Then use rubber nosed pliers in right hand, grip section tightly and turn to right with left hand in opposite direction to unscrew section containing point and feed. See Fig. 1.

---

## TO REMOVE THE GOLD NIB

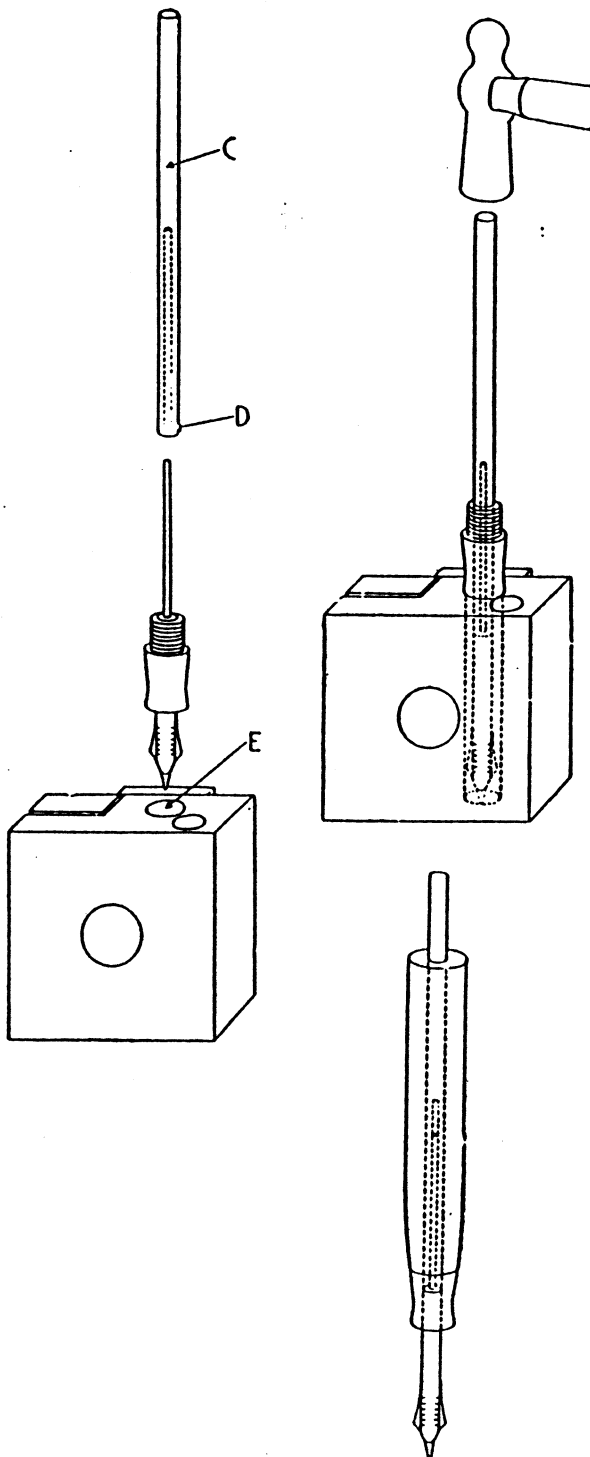

Place the nib and feed into the collar "E". Slip the channel "D" of the driver "C" over the breather tube and with light taps of a hammer drive out the nib and feed.

Should the Vacumatic pen be of the old style, which has a one-piece section barrel, the same procedure may be applied although the section cannot be removed. Instead, remove the filler unit and insert the driver "C" from the end of the barrel. The driver "C" was made purposely long enough to fit in one-piece section-barrel pens.

### TO REMOVE FILLER UNIT

Use same tool and procedure as you would in "51" barrel. See Page 12.



Round brush  
10c net

Then dip barrel cap-section and feed in cold clean water and brush out with round brush to clean dried ink and dirt from the inside of the cap and barrel. Dry with clean cloth.

### TO RE-ASSEMBLE VACUMATIC PENS

First replace completely filler unit in barrel using same procedure as in fitting "51" filler unit. See Page 14. Figures 2 and 3.

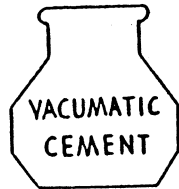

Vacumatic Cement  
10c net

### TO FIT NIB AND FEED

Apply small quantity of Vacumatic Section Cement on threads of section then screw section snugly into barrel using rubber nosed pliers.



Feed right

Then place point over feed so that upper part of feed does not go above point. Hold both in position with forefinger and thumb of right hand. Hold barrel and section in left hand, push point and feed into section snugly. Then grip point and feed firmly with Bernard rubber nosed pliers about one-eighth inch from top of section forcing feed and point into section.

---

THE PARKER VACUMATIC PEN

---

Then check point for proper depth into section so that cap will not hit point. Use point depth gauge #9601.

Place top section against lower part of gauge with point on top of gauge. The top of point should reach designated line as follows:

- A -  $5/8$ " is used for the Midget and Gold Lady pens.
- B -  $21/32$ " is used for all Lady Vacumatic, Lady Duofold, Lady Challenger and Lady Parkette models.
- C -  $23/32$ " is used for the Junior Challenger and Junior Parkette.
- D -  $3/4$ " is used for the Junior Vacumatic and Major Vacumatic and Junior Duofold.
- E -  $7/8$ " is used for all \$10.00 Vacumatics and Senior Duofolds.
- G - is used to grade distance from top of feed to top of point.

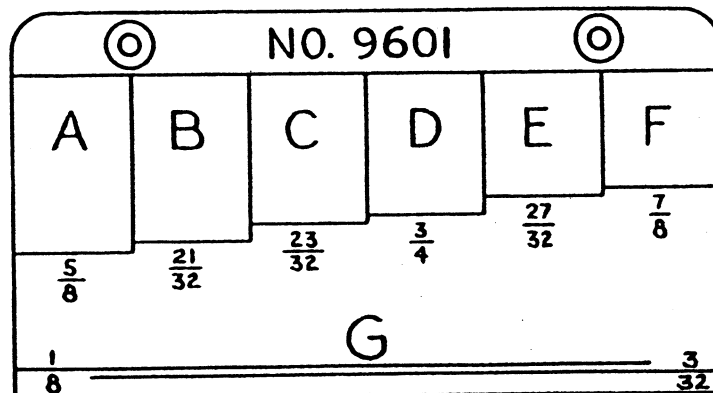

Point Gauge No. 9601  
Price 90c net

---

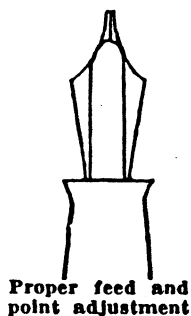

## CHECK POINT FOR PROPER SPACING

Be sure that both prongs are even with a slight space between prongs. Use metal spacing sheets to determine correct spacing depending upon degree of point fineness as pen illustration shown on Page 17 of "51" Instructions.

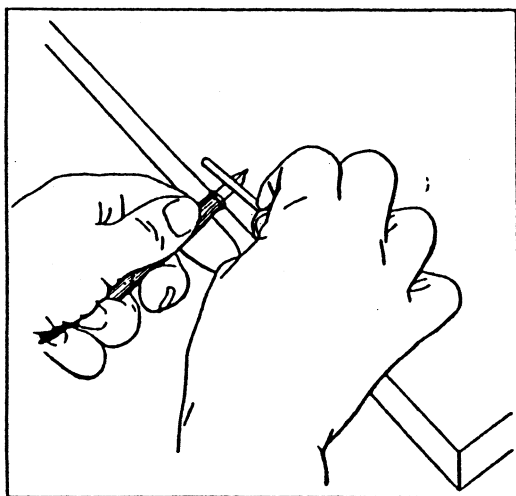

Fig. 1

## TO INCREASE OR DECREASE THE FLOW OF INK

To Increase Flow hold pen point firmly on end of bench with face up, then use round smooth metal rod and roll over face of point over the air hole with slight pressure while rolling. See Fig. 1.

Another method is to raise each prong of the gold point with the thumb nail one prong at a time, then check point for alignment and flow. See Fig. 2.

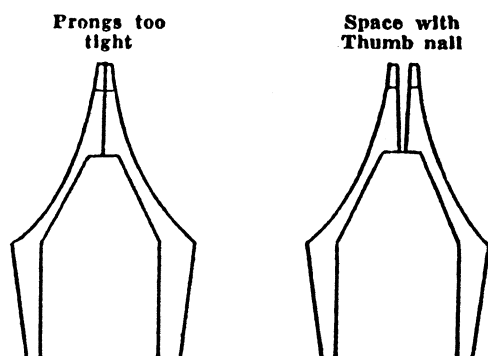

Fig. 2

To Decrease Flow close space slightly using thumb nail pressing one prong at a time downward then check prongs for correct alignment.



## TO REFINISH OR SMOOTH THE IRIIDIUM TIP

Sometimes a customer will bring a pen with the complaint that the pen scratches or you may find that while demonstrating a new pen to a prospect that while the pen writes smoothly in your hand, in the customer's hand it seems to scratch the paper. This happens because the customer may hold the pen at a slightly different angle than you.

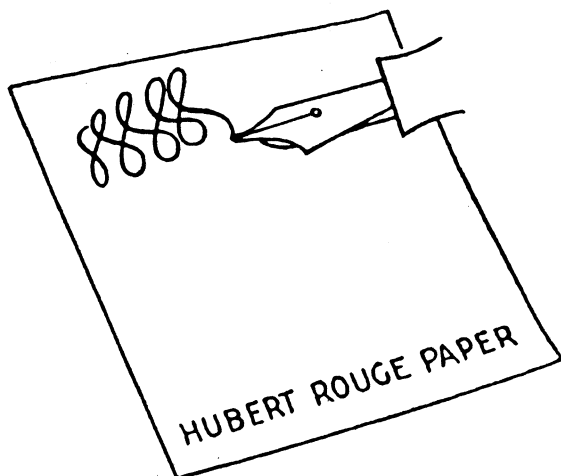

Sheet 5c net

A scratchy pen point can be smoothed up easily by simply running the point in figure eights over a special type of polishing paper, known as Hubert Rouge Paper. This paper is imported and can be furnished upon request.

**Warning -** Before using this paper be sure that prongs are evenly lined up otherwise you will spoil the point.

## FLAT NOSE PLIERS

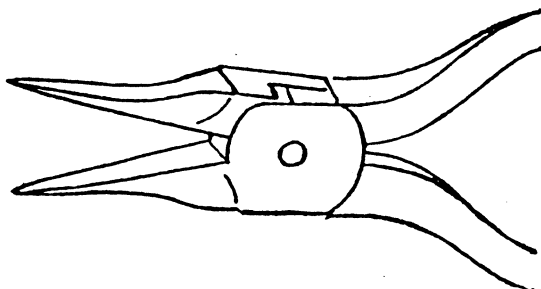

Flat nose pliers  
Price \$3.00 net

Only an experienced person can adjust the ink flow of the nib with a pair of small pliers. The jaws of these pliers must be especially ground to a thin edge. We can supply them upon request.

Care must be taken to keep the pliers away from the iridium tip of the nib. An inexperienced person is likely to break off the iridium when trying to bend the prongs with the pliers.

## TO REMOVE THE CLIP SCREW AND CLIP BUSHING

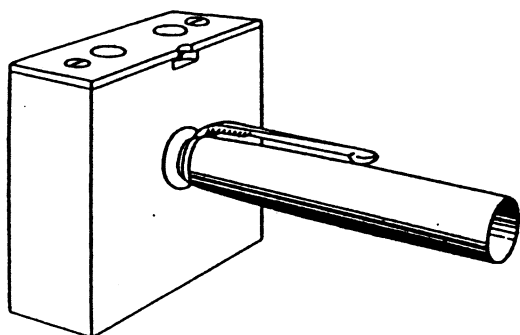

Fitting Block

### TO REMOVE CLIP SCREW

On the underside of the fitting block is a small rubber disc "H". Hold the block in the left hand and press the clip screw firmly against this rubber disc. Give the cap a sharp twist to the left to loosen the clip screw to remove or unscrew it.

### TO REMOVE CLIP SCREW BUSHING

After clip screw has been removed as per above instructions, take a small screw driver and fit into slit of bushing and turn out bushing. This will also remove the clip from the cap.



Flat Brush  
55c net

### FLAT BRUSH

To remove dried ink or sediment which has accumulated on feeds, brush the cutting in the feeds with the flat brush which has been dipped in water.

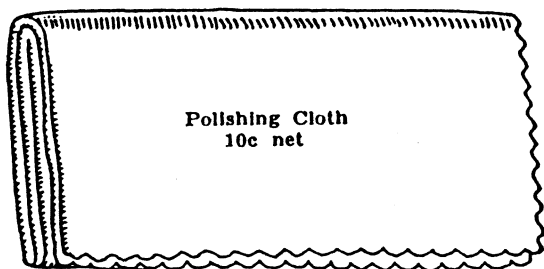

Polishing Cloth  
10c net

### POLISHING CLOTH

This polishing cloth has been chemically treated; with it you may restore the lustre to the barrel of the pens.



1 Oz. Rouge  
10c net

### POLISHING ROUGE

Apply a small portion of the rouge to a cloth and rub over the gold parts; such as, pen point, gold bands and clip to give a high lustre.

---

THE PARKER DUOFOLD PEN

---

# The Parker Duofold Pen

## SECTIONAL VIEW DUOFOLD PEN

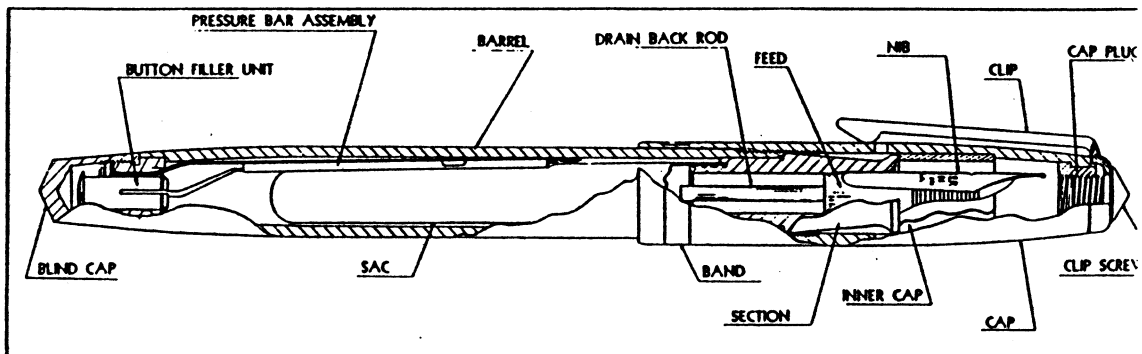

## INSTRUCTIONS FOR FILLING PARKER DUOFOLD PENS

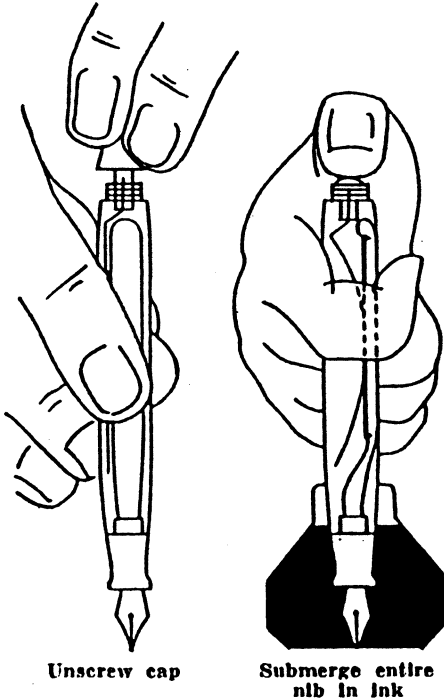

Unscrew the blind cap on the end of the barrel and insert pen in a bottle of good fountain pen ink. It is necessary that the nib and feed be completely submerged in the ink. Press button with thumb to expel all air from ink sac. Release thumb from button instantly and let the nib stay in the ink while you count ten. The ink sac should then be filled.

Be sure to explain to the buyer of a Parker Pen that he must give it time to fill. Some people press the filler-button and withdraw the pen almost immediately after releasing pressure on the button and expect the sac to be filled.

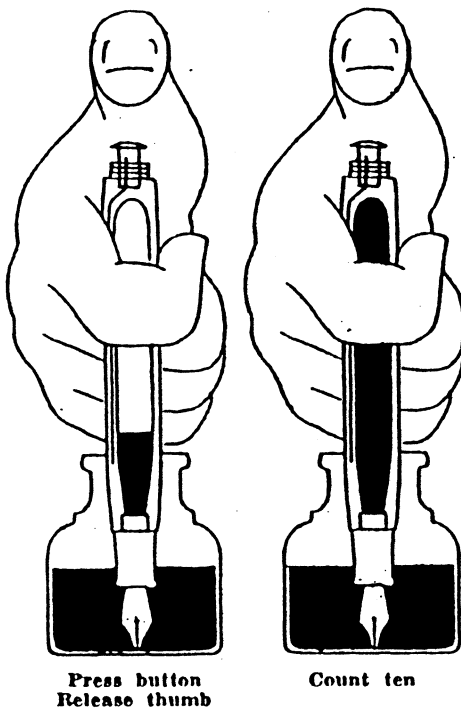

To fill the sac completely, the point should remain immersed in ink at least ten seconds. After ten seconds have elapsed, withdraw the pen from the ink bottle and with a cloth wipe the gold nib clean. Screw cap on the pen; it is now ready for writing.

Although all pens are apparently identical some may require more time to fill than others because of minute variations in the dimensions of feed channel or the degree of elasticity of the rubber sac. Thus some pens may need as much as fifteen seconds' time to fill completely.

**PARTS FOR SAC PENS (Button Filling)**

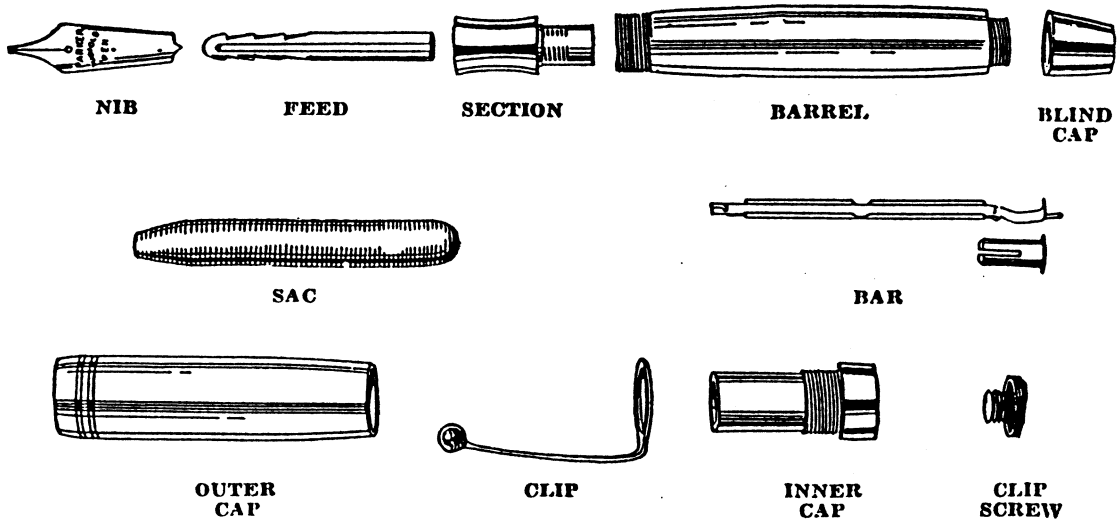

**PROPER METHOD TO TAKE PARKER SAC AND BAR PENS APART  
(Button Filling)**

Remove small blind cap from end of barrel, then place end of button in button puller which should be screwed against work bench and pull barrel toward you to remove button. Now remove the pressure bar, pulling it out carefully.

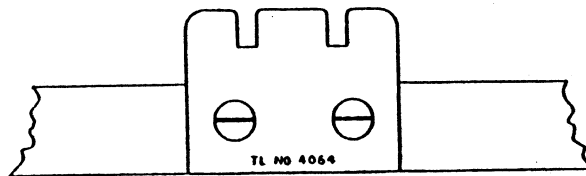

**Button puller**  
50c net

Straight-shaped pens have a screw section. Streamlined pens are fitted with a slip section.

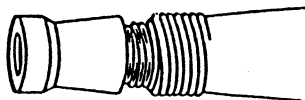

**Screw Section**

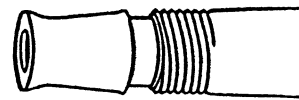

**Slip Section**

Before removing the section from the barrel, tap the barrel at the threads with a blunt tool or small hammer. This will loosen the shellac which was used in fitting the section. Then with a piece of flat rubber, grip the section tightly. If it is a screw section, unscrew it. If it is a slip section pull it straight out. Do not rock it out, you may split the barrel.

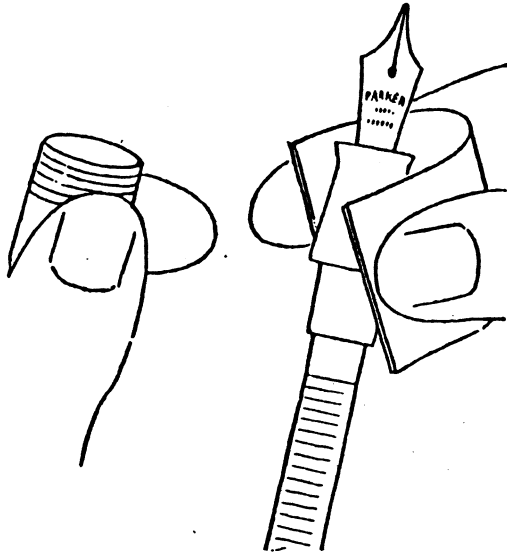

If it is a screw section, use the rubber nosed pliers as shown in removing Vacumatic section. See Page 28.

Then pull sac from section. Check section to see if it is free from dried shellac or adhering rubber.

Use a flat file to remove any shellac or dried rubber that may stick to section nipple.



Flat file  
20c net

Remove point and feed from section using Block and Rod as per instructions for removing Vacumatic point and feed. See Page 29.

Also wash feed section and point as shown for Vacumatic. See page 30.

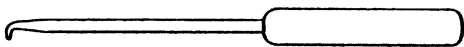

Hook Tool  
No. 10201 50c net

For hooking old sacs out of barrel and hooking pressure bars out of lever side filling pens.

---

THE PARKER DUOFOLD PEN

---



Shellac, 15c bottle net

To fit point and feed in section same procedure as shown in Vacuum Instruction. See page 30.

Then remove section point at feed from barrel to install proper size sac. To get proper diameter of sac, drop it in barrel. It should drop in freely.

Apply small quantity of shellac to nipple of section and slip sac over nipple of section, using sac stretcher as shown in Fig. 1. Be careful not to allow shellac to get in feed channel.

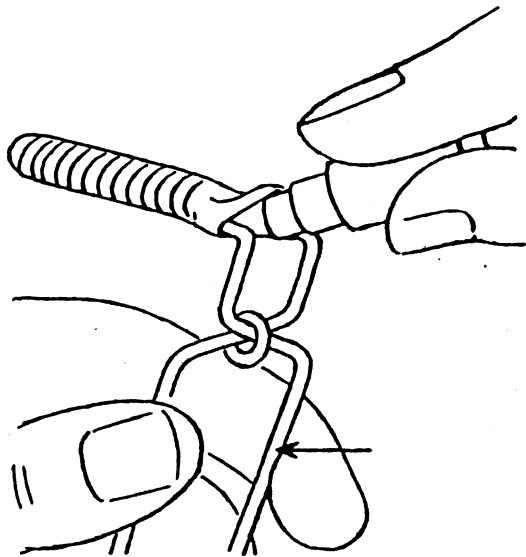

Fig. 1

SAC SIZES

	Length Inches	Length M.M.	Di
Senior	2½	63	
Special	2½	63	
Long	2½	63	
Intermediate	2¼	57	
Short, Junior	2	51	
Lady	2	51	
Pastel	2	51	
Midget	1½	37	

If rubber sac should be too long cut off surplus.

Then put a little shellac on that part of the section which touches the inner wall of the barrel and push sac and section into the barrel.

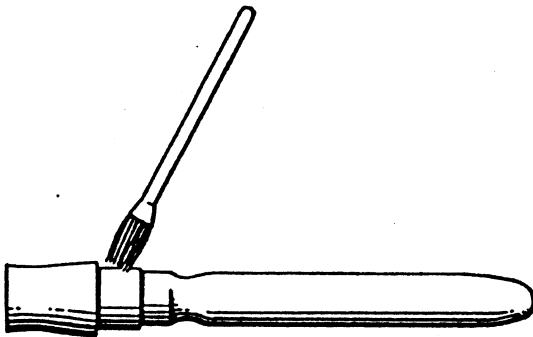

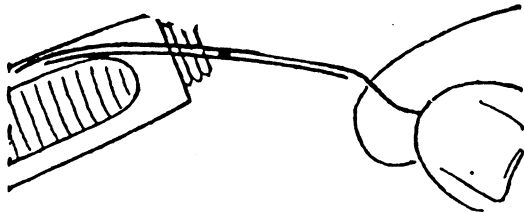
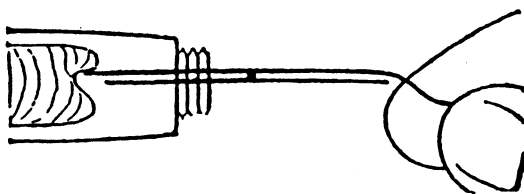
**Pressure Bar Inserted****Right****Wrong****TO INSERT PRESSURE BAR**

Care must be taken when inserting the pressure bar, that the small plate of the bar faces the sac.

If you do not have the proper bar slide tool, bend the front end of the bar upwards toward the wall of the barrel. Make sure when you push the bar in that the sac will not be telescoped. See illustration.

**IN USING BAR SLIDE TOOL**

Insert tool against inner wall of barrel, then slide pressure bar over tool into barrel. Then hold bar with thumb and pull out slide tool. See illustration.

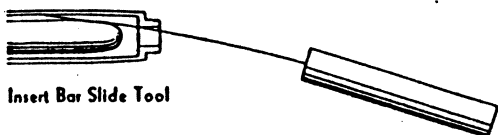
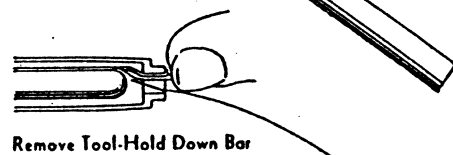
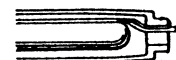
**Insert Bar Slide Tool****Insert Pressure Bar over Tool****Remove Tool-Hold Down Bar****Pressure Bar**

This will prevent possible telescoping or puncturing sac.

After the pressure bar is properly fitted, replace the pressure button.

Be sure that the pressure bar works properly by holding the pen close to the ear and pressing the button. You should feel a whiff of air escaping through the air hole in the gold nib.

Tool No. 10634  
Price 25c net



THE PARKER DUOFOLD PEN

PRESSURE BARS

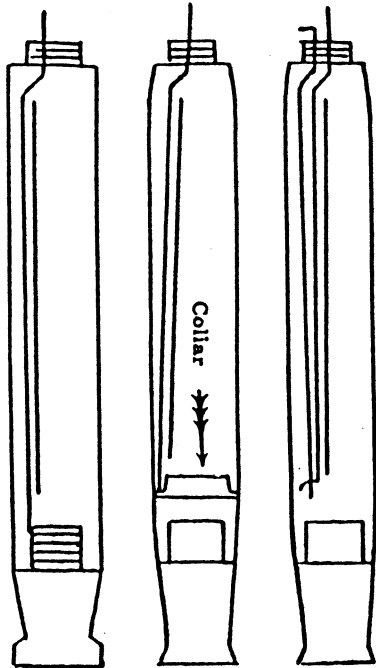

A B C

Parker Sac Pens may be fitted with one of the following pressure bars:

A - Screw Section Bar which was used for straight shaped pens and so named because it rested against the screw section. The section screws into the barrel.

B - Slip Section Bar, which is used in streamline pens with a metal collar or "collar" inside the barrel—the bar rests against the "collar".

C - Triple Bar, which eliminates the pressure of a "collar". This bar is now regularly fitted in buttoning Parker Pens.



A B C

Pressure Bars	Length	Length
List Price 10¢	Inches	Millimeters
<b>Screw Section Bar—</b>		
Long .....	3 3/8	86
Short .....	2 5/8	67
Midget .....	1 7/8	48
<b>Slip Section Bar—</b>		
Long .....	2 3/4	69
Short .....	2 1/4	61
<b>Triple Bar—</b>		
Long .....	2 3/4	69
Intermediate .....	2 1/2	64
Short .....	2 1/4	61

## LEAKING

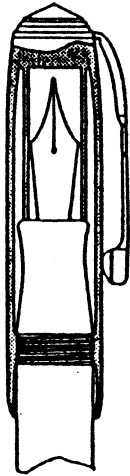

“Leaking” is a term applied to two different conditions.

(1) If the cap of the pen is not screwed on securely when not in use, the ink may ooze out of the feed and soil the inner wall of the cap. When the user later unscrews the cap, his fingers may be soiled with ink which has accumulated on the threads of the barrel and he will complain that his pen “leaks”.

The purpose of the cap is to effect a hermetic sealing which makes the escape of ink impossible. To accomplish this, the cap must be screwed on until a “click” is heard. The click is produced by the tight closure of the inner cap over the section.

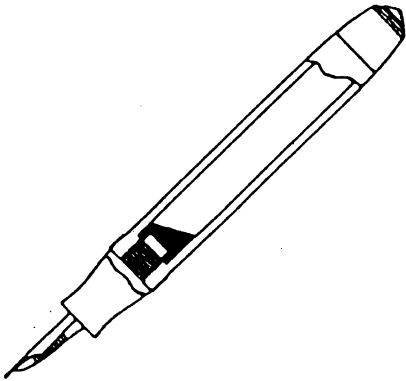

(2) When a pen is almost empty and needs refilling, ink will flow faster than normally. This is true with any fountain pen when the volume of air in the barrel is relatively much greater than the volume of ink. Air is highly expansible and the warmth of the hand expands the air in the barrel and forces the ink out through the feed channel. This is probably the basis for most complaints about “leaking” or “flooding”—it is really a signal to refill the pen which, of course stops the trouble.

---

## PROPER CARE OF A FOUNTAIN PEN

The fountain pen is a delicate instrument and should be treated as such.

Never fill a pen from an ink bottle which has been left uncorked for some time, or from ink which contains sediment, for dust and dirt particles will clog the fine ink channel in the feed.

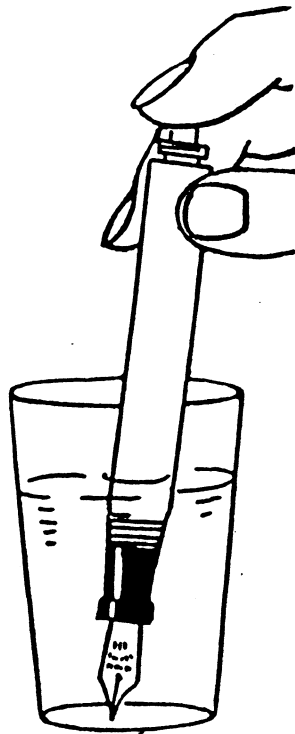

In the course of time it is quite natural that even with use of the best ink some small particles of sediment will enter the ink sac and obstruct the flow of ink through the channel.

It is, therefore, necessary to clean the fountain pen from time to time in order to keep it in good condition. This cleaning process is very simple. Fill a tumbler with clean clear water, insert the pen just as for filling, fill the reservoir with water and expel it again. Repeat this flushing operation four or five times to wash away all sediment in the channel. To insure thorough cleansing of the pen, fill the pen with water and let it stand point down in a tumbler of water overnight. This dissolves and removes all ink crusts.

You will not find it necessary to ever clean a pen if you use "Quink with Solv-x".

This harmless secret solvent cleans all pens as they write—prevents corrosion—dissolves sediment.

## REFERENCE FITTING CHART FOR REPAIR ASSEMBLY

Name	Retail Price	Point Size	Section	Feed	Feed & Breather Tube Length	Fitting Length
PARKETTES						
Parkette	\$1.25	Rador	Parkette	4 Chall.	1 - 21/32	23/32
Lady DeLuxe	1.75	Rador	2 Window	2 Chall.	1 - 19/32	21/32
Junior DeLuxe	1.75	Rador	4 Window	4 Chall.	1 - 21/32	23/32
Zephyr	1.95	Zephyr	Zephyr	4 Chall.	1 - 21/32	21/32
Writefine	1.00	Rador	Zephyr	4 Chall.	1 - 21/32	23/32
NON GUARANTEED VACS						
Lady—Short Blind Cap	5.00	2 - 5.00	2 Vac. O.S.	2 Vac.	2 - 15/32	21/32
Lady—Long Blind Cap	5.00	2 - 5.00	2 Vac. N.S.	2 Vac.	1 - 15/16	21/32
Jr.—Short Blind Cap	5.00	4 - 5.00	4 Vac. O.S.	4 Vac.	2 - 9/16	3/4
Jr.—Long Blind Cap	5.00	4 - 5.00	4 Vac. N.S.	4 Vac.	2 - 21/64	3/4
Lady—Short Blind Cap	7.50	2 - 5.00	2 Vac. O.S.	2 Vac.	2 - 15/32	21/32
Lady—Long Blind Cap	7.50	2 - 5.00	2 Vac. N.S.	2 Vac.	1 - 15/16	21/32
Jr.—Short Blind Cap	7.50	4 - 5.00	4 Vac. O.S.	4 Vac.	2 - 27/32	3/4
Jr.—Long Blind Cap	7.50	4 - 5.00	4 Vac. N.S.	4 Vac.	2 - 21/64	3/4
GUARANTEED VACS						
Lady—Long Blind Cap *	8.75	2 - 8.75	2 Vac. N.S.	2 Vac.	1 - 15/16	21/32
Major—Long Blind Cap *	8.75	4 - 8.75	4 - 8.75	4 - 8.75	2 - 21/64	3/4
Sr.—Long Blind Cap *	10.00	6-10.00	6 Vac. N.S.	6 Vac.	2 - 19/32	7/8
Sr.—Short Blind Cap *	10.00	6-10.00	6 Vac. O.S.	6 Vac.	3 - 3/32	7/8
Sr. Sl.—Short Blind Cap *	10.00	6-10.00	6 Vac. O.S. Sl.	6 Vac.	3 - 3/32	7/8
Sr.—Long Blind Cap *	10.00	6-10.00	4 - 8.75	4 - 8.75	2 - 31/64	3/4
Lady Imperial	12.75	2 - 8.75	2 Imperial	2 Vac.	2 - 1/8	21/32
Junior Imperial	12.75	4 - 8.75	4 Imperial	4 - 8.75	2 - 5/8	3/4

Notes— Asterisk Indicates Guaranteed      Pierced Points at Heel Indicate Non-Guaranteed  
 O.S. Indicates Old Style                      Starred Points at Heel Indicate Guaranteed  
 N.S. Indicates New Style                      Vac. Points not Pierced at Heel are Guaranteed

REFERENCE FITTING CHART FOR REPAIR ASSEMBLY

Name	Retail Price	Point Size	Section	Feed	Feed & Breather Tube Length	Fitting Length
Vest Parker	* \$5.00	2 Duo.	Vest Parker	Vest Parker	29/32	19/32
Lady—O.S.	* 5.00	2 Duo.	2 Duo. Screw	Vest Parker	1 - 7/16	21/32
Lady—N.S.	* 5.00	2 Duo.	2 Duo. Slip	Vest Parker	1 - 7/16	21/32
Junior—O.S.	* 5.00	4 Duo.	4 Duo. Screw	4 Parker	1 - 19/64	3/4
Junior—N.S.	* 5.00	4 Duo.	4 Duo. Slip	4 Parker	1 - 19/64	3/4
Senior—O.S.	* 7.00	6 Duo.	6 Duo. Screw	6 Parker	1 - 17/32	7/8
Senior—N.S.	* 7.00	6 Duo.	6 Duo. Slip	6 Parker	1 - 17/32	7/8
Slender Lady	3.50	2 Chall.	2 Window	2 Chall.	1 - 19/32	21/32
Junior	3.50	4 Chall.	4 Window	4 Chall.	1 - 21/32	23/32
Lady Sacless	3.95	2 Chall.	2 Vac. N.S.	2 Vac.	1 - 15/16	21/32
Junior Sacless	3.95	4 Chall.	4 Vac. N.S.	4 Vac.	2 - 21/64	23/32
Lady Sacless	5.00	2 Chall.	2 Vac. N.S.	2 Vac.	1 - 15/16	21/32
Junior Sacless	5.00	4 Chall.	4 Vac. N.S.	4 Vac.	2 - 21/32	23/32
Lady Sacless	* 8.75	2-8.75 Duo.	2 Vac. N.S.	2 Vac.	1 - 15/16	21/32
Junior Sacless	* 8.75	4-8.75 Duo.	4 Maj. Vac.	4 Vac.	2 - 31/64	3/4
Lady Sac	2.95	2 Chall.	2 Window	2 Chall.	1 - 19/32	21/32
Junior Sac	2.95	4 Chall.	4 Window	4 Chall.	1 - 21/32	23/32

DUOFOLDS

CHALLENGER

Lady	2.75	2 Chall.	2 Chall.	2 Chall.	1 - 19/32	21/32
Junior	2.75	4 Chall.	4 Chall.	4 Chall.	1 - 21/32	23/32
Lady DeLuxe	3.50	2 Chall.	2 Chall.	2 Chall.	1 - 19/32	21/32
Junior DeLuxe	3.50	4 Chall.	4 Chall.	4 Chall.	1 - 21/32	23/32
Lady Royal	5.00	2 Chall.	2 Chall.	2 Chall.	1 - 19/32	21/32
Junior Royal	5.00	4 Chall.	4 Chall.	4 Chall.	1 - 21/32	23/32

Notes— Asterisk Indicates Guaranteed  
 O.S. Indicates Old Style  
 N.S. Indicates New Style  
 Starred Points at Heel Indicate Guaranteed  
 Pierced Points at Heel Indicate Non-Guaranteed  
 Vac. Points not Pierced at Heel are Guaranteed

## TO REMOVE STAINS INSIDE PEN BARREL

Flush pen with vinegar, for a safe general purpose cleanser to remove ink stains from inside of the barrel of transparent Vacumatic pen. Vinegar cleans the inside wall and leaves the barrel transparent.

Remove all traces of vinegar by flushing the pen several times with water, before filling it with ink.

## TO REMOVE STAINS ON OUTSIDE OF BARREL

Moisten a piece of tissue paper and put some good tooth paste on it. Then rub the soiled part of barrel and the stain will be easily removed.

## TO KEEP PENS CLEAN

### Use Parker Quink containing Solv-x

For writing satisfaction fill pens with Parker Quink, the only ink containing Solv-x.

Pen-protecting Solv-x is a scientific secret formula of harmless solvents and humectants, developed by Parker scientists exclusively for Parker Quink.

Solv-x not only cleans a pen as it writes, but due to its humectant properties, absorbs moisture from the air . . . and thus helps to keep the pen point from drying off.

Quink comes in nine brilliant colors

- 4 Permanent: Black, Blue-Black, Royal Blue, Red
- 5 Washable: Blue, Black, Green, Violet, Brown



## PARKER "51" INK

### For use in "51" Pens only

"51" Ink eliminates blotting and smudging—starts in a split-second, and dries in a split-second. It's waterproof and sunfast. All colors are permanent. The "high velocity" of Parker "51" Ink gives it high-speed penetration into paper. Developed exclusively for use in Parker "51" pens, "51" Ink will not work well in other pens.

"51" Ink comes in four permanent colors

India Black, Tunis Blue, China Red, Pan American Green



## REPAIR TOOL ASSORTMENT NO. 320

	Net Price
1. Bernard Pliers - for fitting nib, feed in section.....	\$1.60
2. Nib Pliers - for spacing and adjusting nibs.....	3.00
3. Flat Brush - for brushing off threads and feeds.....	.55
4. Flat File - for filing and cleaning off nipples of section.....	.20
5. Round Bristle Brush - for cleaning barrels and caps.....	.10
6. Alcohol Lamp - for heating down feeds, shells, etc.....	.10
7. Polishing Cloth - for wiping off repaired pen.....	.10
8. Pencil Screw Driver - for tightening mechanisms through eraser cup holder.....	.10
9. One Pencil Point Drill for Writefine Lead - for drilling out clogged pencil tips.....	.55
10. One Pencil Point Drill for thick lead - same purpose as No. 9	.55
11. Gold Crayon - for filling in engraving.....	.10
12. Silver Crayon - for filling in engraving.....	.10
13. 1 Pc. Hubert Rouge Paper No. 000 - for smoothing nibs.....	.05
14. 1 Bottle Liquid Polish 2 oz. - for polishing barrels and caps with cloth.....	.10
15. 1 Bottle "51" Cement 2 oz. - for cementing shell on barrel threads. ....	.10
16. 1 Bottle Vacumatic Cement 2 oz. - for cementing screw sections threads in barrels.....	.10
17. 1 Bottle of Diaphragm Lubricant 2 oz. - to be applied on upper outer part of diaphragm to aid in inserting filler unit into barrel.....	.10
18. 1 Bottle of Orange Shellac 2 oz. - to apply on nipple of sac pen sections to hold on sac.....	.15
19. 1 Pair Section Pliers - (protect jaws with rubber tubing) for removing sections and shells from pen barrels.....	.50
20. 1 oz. Rouge Gold Polish - to be applied on cloth for polishing metal parts.....	.10
21. 1 Sac stretcher - for stretching mouth of sac to be slipped over shellaced section nipple.....	.05
22. 4 Pieces Rubber Tubing - for covering jaws of section pliers Bernard pliers.....@ .01	.04
23. 1 Piece Flat Rubber - to be used as friction hand grip to hold pen barrel, tighten clip screws, etc.....	.01
24. 1 "51" Nib Puller 8573R1 - for removing nib from front end of shell.....	1.00
25. 1 Dis-Assembly Block and Rod #9592 - to drive out feed and nib from section and to tighten or loosen clip screws and to pull button from button filling pens.....	.50
26. 1 Fitting Gauge #9601 - for gauging extension of nib beyond section and extension of nib beyond feed.....	.90
27. 1 Pressure Bar Insertion Tool #10534 - to be inserted into barrel over sac so pressure bar may be inserted into barrel without puncturing sac.....	.25
28. 1 Filler Unit Clamp #8674 - for removing and inserting all filler units except senior lock filler units.....	1.00
29. 1 "51" Pen Capacity Gauge - to test capacity of "51" pen....	.50
30. 5 Spacing Steels - for medium nibs.....@ .03	.15
31. 5 Spacing Steels - for fine nibs.....@ .03	.15
32. 1 Oversize Filler Unit Clamp - for removing and inserting senior lock type filler unit.....	1.00
33. 1 Magnifying Glass - for inspecting and adjusting nibs.....	1.00
34. 1 Arbor #8057 for "51" Pen Caps - for removing and fitting clips. ....	1.00
35. 1 Hook Tool #10201 - for hooking old sacs out of barrels and hooking pressure bars out of lever fill pens.....	.50

### ADDITIONAL REPAIR TOOLS AVAILABLE

	Net Price
1. Regular Nib Grader - for gauging nibs to match fineness.....	\$1.00
2. Extra Fine and Needle Nib Grader - for gauging nibs to match fineness.....	1.00
3. 1 Clip Screw Wrench for "51" Pen Cap #7291 - for loosening and tightening clip screw bushings.....	1.00
4. 1 Clip Screw Wrench for Writefine Pencils #7122 - for loosening and tightening clip screw bushings.....	1.00
5. 1 "51" Barrel Thread Tap - for tapping out filler unit thread in barrel.....	4.00
6. 1 Cap Thread Tap No. W - for Jr. Vacumatic and Major extended filler Vacumatic.....	4.00
7. 1 Cap Thread Tap No. N - for all Lady pens.....	4.00
8. 1 Cap Thread Tap No. P - for Junior and Standard lock filler Vacumatic, Jr. Challenger, Jr. Parkette, Jr. Streamline Duofold and Jr. Straightshape Duofold.....	4.00
9. 1 Cap Thread Tap No. Q - for Sr. lock filler Vacumatic, Sr. Straightshape Duofold and Sr. Streamline Duofold.....	4.00
10. 1 Cap Thread Tap No. U - for Sr. extended filler Vacumatic.	4.00

### FOR DEALERS HAVING A BENCH LATHE, THE FOLLOWING LATHE TOOLS ARE AVAILABLE

1. 1 Carbaloy Tipped Turning Tool #8675A - for turning blind cap joints on "51" pens. This tool can be resharpened only by a machinist. Do not try to sharpen on oil stone.....	1.50
2. 1 Thread Chasing Tool for 36 Threads - for reducing front barrel thread diameter on Duofold, Vacumatic, Challenger, Parkette, and Writefine Pens.....	1.00
3. 1 Facing Tool - for facing back sections, blind cap joints.....	.50
4. 1 Wide Turning Tool - for turning down wide surfaces on all pens except "51" pens.....	.50
5. 1 Narrow Turning Tool - for turning down narrow surfaces on all pens except "51" pens.....	.50
6. 1 Arkansas Oil Stone size 1" x 2" x 4" - for sharpening all turning and facing tools except the Carbaloy Turning Tool.....	2.00

Total \$34.00



## ENGRAVING CRAYON

For filling in names engraved on barrels, we have prepared special crayon. It is available in two colors, Silver or Gold, and priced at 10¢ net per stick.

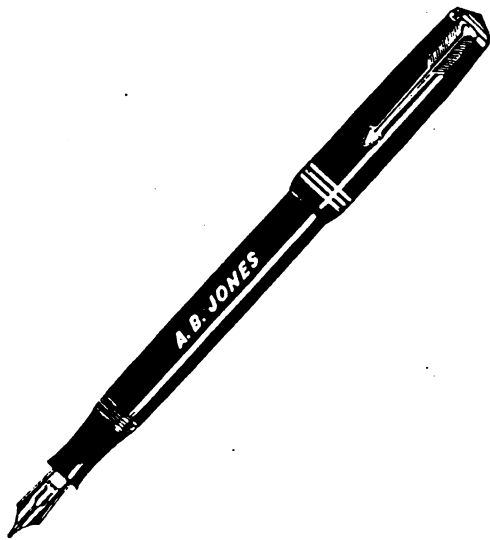

10c net per stick

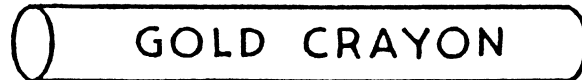

10c net per stick

## LIQUID POLISH

To restore a high lustre to the pen barrel apply liquid polish so that it forms a thin coat over the entire pen holder. Allow to dry for a few seconds; then rub the pen well with a dry soft cloth until it is dry.



Bottle of  
Liquid Polish  
10c net

# Parker Gold Pen Points

All Parker gold pen points are made of 14K gold, tipped with "oil-smooth" Osmiridium. For the Parker "51" pen there is a choice of 9 rigid pen points. For the Vacu-

matic pen there are 18 different pen points, 9 rigid, 9 flexible as shown below.

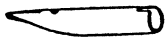

Parker "51" points can be supplied in the 9 rigid points. Flexible points cannot be made for the Parker "51" pen because of the construction of the pen.

## Rigid Gold Pen Points

<b>Needlepoint Rigid</b>	<b>Accountant Rigid</b>	<b>Extra Fine Rigid</b>	<b>Fine Rigid</b>	<b>Medium Rigid</b>	<b>Broad Rigid</b>	<b>Stub Rigid</b>	<b>Oblique Rigid</b>	<b>Left Oblique Rigid</b>
For sharp hair line work only.	For very fine figures in book-keeping.	For draftsmen & bookkeeping	For fine writing.	For general writing, manifold.	For heavy writing.	For extra heavy writing.	For thin and wide strokes.	For left hand writing.

## Flexible Gold Pen Points

<b>Needlepoint Flexible</b>	<b>Stenographer Flexible</b>	<b>Extra Fine Flexible</b>	<b>Fine Flexible</b>	<b>Medium Flexible</b>	<b>Broad Flexible</b>	<b>Stub Flexible</b>	<b>Oblique Flexible</b>	<b>Left Oblique Flexible</b>
For sharp hair line work only.	For stenographic work.	For draftsmen & bookkeeping	For fine writing.	For general writing and shading.	For heavy writing.	For extra heavy writing.	For thin and wide strokes.	For left angle writing.

## List Price of Gold Pen Points & Range of Points Made

Extra fine Fine Medium Broad Stub Oblique	Parker Gold Pen Points Parker "51"	List Price \$3.50	Pen Points Available in Rigid only: 9 styles of points.
	Sr. Maxima Vacumatic Major Vacumatic Debutante Vacumatic Junior Vacumatic Sub-Deb Vacumatic	4.00 3.50 3.50 2.00 2.00	Rigid and Flexible: 18 styles of points.
	Duofold No. 4 for Men's \$3.95 and \$2.95 pen Duofold No. 2 for Lady's \$3.95 and \$2.95 pen	1.25 1.25	
	Parkette	1.00	Rigid and Flexible: Extra Fine, Fine, Medium.

All prices subject to 20% Federal Excise Tax.

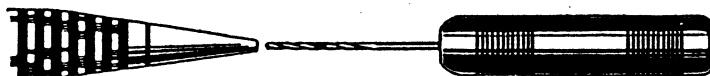

### Pencil Point Drill, 55¢ net

Sometimes the lead gets jammed in the pencil point. The clogged lead can be removed by means of the pencil point drill. Simply insert the drill in the front end of the pencil and turn the drill until all jammed lead has been removed.

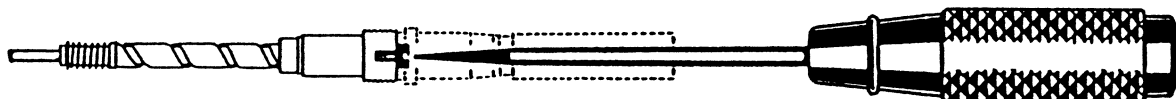

### Pencil Screw Driver, 10¢ net

This screw driver has been made to fit the screw in the inside of the pencil mechanism. This screw holds the mechanism assembly together. Insert the screw driver from the rear to take screw out and take mechanism apart.

## THE PARKER LEAD CARTRIDGE

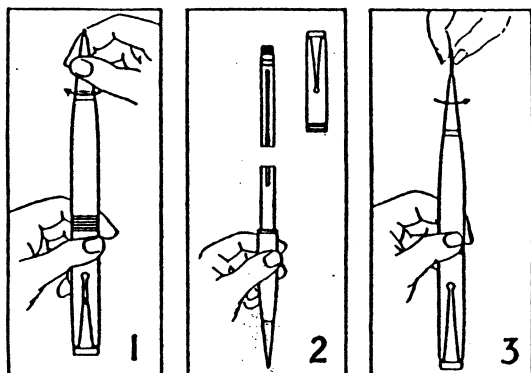

The leads and the eraser in Parker Pencils are contained in a special cartridge. The entire cartridge may be removed and a new one inserted, thus insuring you of receiving best quality leads and a fresh eraser at all times.

## PARKER WRITEFINE PENCIL

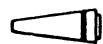

Point

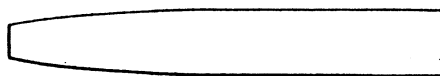

Barrel

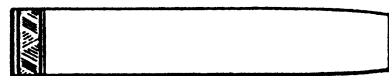

Cap

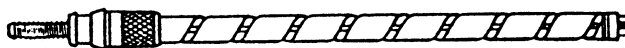

Movement

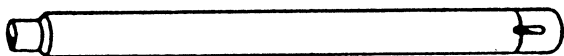

Eraser Cup Holder



Clip



Clip Screw

### BARREL ASSEMBLY

Put the small end of the eraser cup holder over small end of movement and push down over knurled brass bushing. Place a drop of shellac on chrome bushing, then slip into barrel. Screw on point.

### CAP ASSEMBLY

Place clip screw into clip and screw these parts into the cap.

If cap fits loose on the eraser cup holder, pinch the latter to an oval shape so that the cap will fit on tight.

PARTS FOR PARKER WRITEFINE PENCILS

List Price	\$30.00 "51" Heirloom	\$15.00 "51" Heritage	\$10.00 "51" Signet	\$7.50 "51" Gold-Cap	\$5.00 "51" Silver or Lustraloy
* Point .....	2.40	2.40	.40	.40	.40
Barrel .....	.70	.70	.70	.70	.70
Mechanism .....	1.00	1.00	1.00	1.00	1.00
Eraser Cup Holder .....	.20	.20	.20	.20	.20
Pair Lead Dividers .....	.05	.05	.05	.05	.05
* Cap .....	17.50	7.50	7.50	5.00	2.50
* Clip .....	8.60	8.60	.60	.60	.60
Bushing .....	.05	.05	.05	.05	.05
Clip Screw .....	.05	.05	.05	.05	.05

List Price	\$6.00 Imperial Major Vacumatic	\$5.00 Imperial Debutante Vacumatic	\$5.00 Sr. Maxima & Maxima Vacumatic	\$4.00 Major & Debutante Vacumatic	\$3.75 Standard & Slender Vacumatic	\$3.75 Junior & Sub-Deb Vacumatic
* Point .....	.40	.40	.40	.40	.40	.40
Barrel .....	1.20	.80	1.20	.80	.80	.70
Mechanism .....	1.00	1.00	1.00	1.00	1.00	1.00
Eraser Cup Holder .....	.20	.20	.20	.20	.20	.20
Pair Lead Dividers .....	.05	.05	.05	.05	.05	.05
Cap .....	3.00	2.75	1.50	1.40	1.00	.90
* Clip .....	.60	.60	.60	.60	.60	.60
Bushing .....	.05	.05	.05	.05	.05	.05
Clip Screw .....	.05	.05	.05	.05	.05	.05

List Price	\$2.50 (\$1.05) Sacless Duofold	\$2.00 (\$1.15) Sac Duofold	\$1.00 Parkette Zephyr	\$2.50 Utility	\$1.50 Utility	\$1.00 Utility
* Point .....	.25	.25	.15	.15	.15	.15
Barrel .....	.50	.40	.30	.30	.30	.30
Mechanism .....	1.00	1.00	.30	.30	.30	.30
Eraser Cup Holder .....	.10	.10	.10	.10	.10	.10
Pair Lead Dividers .....	.05	.05	.05	.05	.05	.05
Center Section .....				1.80	.80	.30
Cap .....	.75	.60	.40			
* Clip .....	.30	.30	.10	.15	.15	.15
Bushing .....	.05	.05	.05			
Clip Screw .....	.05	.05	.05			
Eraser Drive .....				.10	.10	.10
Collar .....				.20	.20	.20

\* Subject to 20% Federal Excise Tax

This tax does not apply to chrome clips or chrome fitted caps.